

# CABINES DEDUCHE & RESGUARDOS DEBANHO

[www.ajnogueira.com](http://www.ajnogueira.com)

**2018**

Cabines de duche e  
Resguardos de banho  
*Shower cabins  
and Bath screens*  
Cabines de douche  
et Écrans de bain



# A.J. NOGUEIRA

# CABINES DEDUCHE & RESGUARDOS DEBANHO

## A.J.NOGUEIRA

A A.J. Nogueira – Unipessoal, Lda, foi constituída em Outubro de 2003, tendo com único sócio e gerente, o Sr. Alberto Nogueira.

Contando com uma equipa jovem, dinâmica e com vasta experiência dedicou-se á produção de cabines de duche e resguardos banho. Tendo como compromisso a satisfação do cliente, a AJ Nogueira, procurou diversificar a sua produção, de forma a acompanhar as tendências do mercado, quer no tocante ao Design, materiais e á qualidade dos seus produtos.

Fazendo dos prazos de entrega uma bandeira, tratando os clientes como aliados, prestando-lhes a máxima assistência e encarando os concorrentes com lealdade, a AJ Nogueira tem vindo a conquistar a sua quota de mercado, contando com uma sólida carteira de clientes.

As suas instalações situam-se na zona industrial de Águeda Norte, com bons e vastos acessos á rede rodoviária nacional, pois está 1Km da IC2, a 7 Km da A 25 e 10 Km da A1. As suas instalações possuem aproximadamente 1.130m<sup>2</sup>, sendo que 130m<sup>2</sup> são de exposição e 37m<sup>2</sup> de área administrativa, possuindo, também bons acessos para cargas e descargas e estacionamento para automóveis.

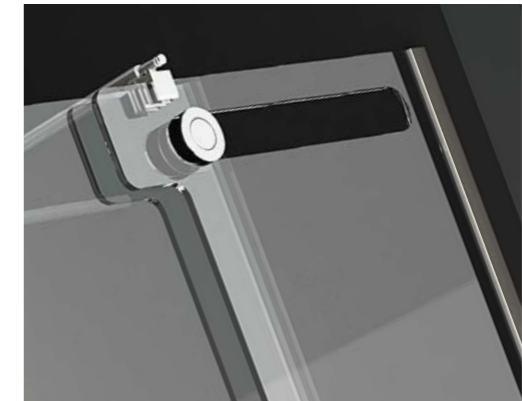

*A.J. Nogueira was founded in 2003 by Mr. Alberto Nogueira.*

*It dedicates itself to the production of Shower cabins and Shower panels.*

*It counts with an dynamic and young team, that incorporates all the "Know-how". Its main compromise is client satisfaction. Following client tendencies it has been diversifying in term of materials, design and quality.*

*Its installations in Portugal are modern, with some 1130 m<sup>2</sup>, complying the exhibition room, services and factory, and very well served in terms of utilities, being near IC2, A25 and A1.*

*A.J. Nogueira est une société constituée l'année 2003 pour M. Alberto Nogueira.*

*Elle se dédie à la fabrication de cabines à bain et panneaux à bain. Elle compte dans ces cadres avec une jeune et dynamique équipe, qui constitue son "Savoir faire". Son compromis majeur c'est la satisfaction du client. En poursuit des tendances des clients, elle diversifie aujourd'hui en termes de design, matériaux et qualité.*

*Ces installations au Portugal son modernes, avec 1130m<sup>2</sup>, incorporant l'espace d'exhibition, les services administratifs et la production, et son emplacement c'est bien servi pour les utilités, et proches des principaux routes, la A1, A25 et IC2.*

[www.ajnogueira.com](http://www.ajnogueira.com)

# CABINES DEDUCHE & RESGUARDOS DEBANHO

Cabines de duche e  
Resguardos de banho  
Shower cabins  
and Bath screens  
Cabines de douche  
et Écrans de bain

04

## ÍNDICE

INDEX / INDEX

**06**  
CABINES  
Cabins / Cabines

**30**  
FRONTAIS  
Frontal / Front

**76**  
PAINÉIS  
Panels / Paneaux

**94**  
ACESSÓRIOS  
Accessories / Accessoires

**96**  
TABELA DE PREÇOS  
Price List / Tableau des Prix



Catálogo geral | General Catalog | Catalogue général

# CABINES DEDUCHE

SHOWER CABINS  
CABINES DE DOUCHE



# FUNCHAL

Cabine | Cabin / Cabine

- Duas portas fixas e duas de correr
- Vidro temperado de 8mm – liso ou fosco
- Altura standard de 200cm
- Largura máxima por lado de 120cm
- Fecho magnético
- Acessórios em aço inoxidável
- Perfil metalizado
- Roletos e guias na base
- Medidas exatas necessárias para encomenda
- Estanquidade média

- Two fixed panels and two sliding doors
- Tempered 8mm glass choose plain or bleak
- Standard height of 200cm
- 120cm standard width for each side
- Magnetic lock
- Inox steel fittings
- Metalized aluminum profiles
- Sliding guides and roles on the base
- Mandatory measures for ordering
- Medium watertightness

Perfil parede  
Wall profile  
Profil de mur



Perfil chão  
Floor profile  
Profil de plancher



- Constitué pour deux panneaux coulissant et deux panneaux fixes
- Verre tempéré de 8mm - choisir plain ou sombre
- Hauteur standard de 200cm
- Largeur standard de 120cm pour coté
- Serrage magnétique
- Composants en acier inox
- Profil d'aluminium métallisé
- Coulisse à la base
- Mesures obligatoires à la demande
- Étanchéité à l'eau moyenne

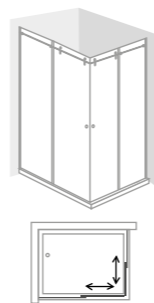

# GALÉ

Cabine | Cabin / Cabine

- Duas portas fixas e duas de correr
- Vidro temperado de 8mm – liso ou fosco
- Altura standard de 200cm
- Largura máxima por lado de 120cm
- Fecho magnético
- Acessórios em aço inoxidável
- Perfil metalizado
- Roletos e guias na base
- Medidas exatas necessárias para encomenda
- Estanquidade média

- Two fixed panels and two sliding doors
- Tempered 8mm glass choose plain or bleak
- Standard height of 200cm
- 120cm standard width for each side
- Magnetic lock
- Inox steel fittings
- Metalized aluminum profiles
- Sliding guides and roles on the base
- Mandatory measures for ordering
- Medium watertightness

Perfil parede  
Wall profile  
Profil de mur



Perfil chão  
Floor profile  
Profil de plancher



- Constitué pour deux panneaux coulissant et deux panneaux fixes
- Verre tempéré de 8mm - choisir plain ou sombre
- Hauteur standard de 200cm
- Largeur standard de 120cm pour coté
- Serrage magnétique
- Composants en acier inox
- Profil d'aluminium métallisé
- Coulisse à la base
- Mesures obligatoires à la demande
- Étanchéité à l'eau moyenne



08



- Opções:
- Medidas especiais
  - Serigrafias especiais

- Options:
- Special measures
  - Special silkscreen

- Options:
- Mesures spéciaux
  - Sérigraphie du verre



09

www.ajnoqueira.com

- Opções:
- Medidas especiais
  - Serigrafias especiais

- Options:
- Special measures
  - Special silkscreen

- Options:
- Mesures spéciaux
  - Sérigraphie du verre



# CAPARICA

Cabine | Cabin / Cabine

- Duas portas fixas e duas de correr
- Vidro temperado de 6mm – liso ou fosco
- Altura standard de 200cm
- Largura máxima por lado de 120cm
- Fecho magnético
- Acessórios em aço inoxidável
- Perfil metalizado
- Roletos e guias na base
- Medidas exatas necessárias para encomenda
- Estanquidade média

- Two fixed panels and two sliding doors
- Tempered 6mm glass choose plain or bleak
- Standard height of 200cm
- 120cm standard width for each side
- Magnetic lock
- Inox steel fittings
- Metalized aluminum profiles
- Sliding guides and roles on the base
- Mandatory measures for ordering
- Medium watertightness

- Constitué pour deux panneaux coulissant et deux panneaux fixes
- Verre tempéré de 6mm - choisir plain ou sombre
- Hauteur standard de 200cm
- Largeur standard de 120cm pour coté
- Serrage magnétique
- Composants en acier inox
- Profil d'aluminium métallisé
- Coulisse à la base
- Mesures obligatoires à la demande
- Étanchéité à l'eau moyenne



Perfil parede  
Wall profile  
Profil de mur



Perfil chão  
Floor profile  
Profil de plancher



Opções:

- Medidas especiais
- Serigrafias especiais

Options:

- Special measures
- Special silkscreen

Options:

- Mesures spéciaux
- Sérigraphie du verre

# ALVOR

Cabine | Cabin / Cabine

- Frontal constituído por um painel fixo e outro de abrir para o exterior
- Painel lateral fixo
- Acessórios em latão cromado
- Perfil metalizado
- Altura standard 195cm
- Vidro temperado de 6mm liso, listado ou fosco
- Fecho magnético
- Medidas exatas necessárias para encomenda
- Estanquidade média

- Front panel with a fixed part and a opening door for the outside
- Fixed lateral panel
- Chromed brass fittings and hinges
- Metalized aluminum profiles
- Standard height 195cm
- Tempered glass of 6mm choose plain, listed or bleak
- Magnetic lock
- Mandatory measures for ordering
- Medium watertightness

- Panel frontal constitué pour une partie fixe et une porte d'ouverture vers l'extérieur
- Panel latérale fixé
- Accessoires en laiton chromée
- Profil d'aluminium métallisé
- Hauteur standard 195cm
- Verre tempère de 6mm choisir plain, listé ou sombre
- Serrage magnétique
- Mesures obligatoires à la demande
- Étanchéité à l'eau moyenne

12

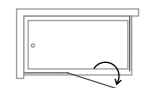
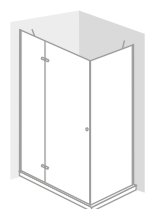

Perfil parede  
Wall profile  
Profil de mur



Perfil chão  
Floor profile  
Profil de plancher



- Opções:
- Medidas especiais
  - Serigrafias especiais

- Options:
- Special measures
  - Special silkscreen

- Options:
- Mesures spéciaux
  - Sérigraphie du verre





14

# TROIA

Cabine | Cabin / Cabine

- Uma porta fixa e uma porta móvel ou ambas móveis
- Abertura para o exterior
- Acessórios em latão cromado
- Perfil metalizado
- Altura standard 195cm
- Vidro temperado de 6mm liso, listado ou fosco
- Fecho magnético
- Medidas exatas necessárias para encomenda
- Estanquidade média

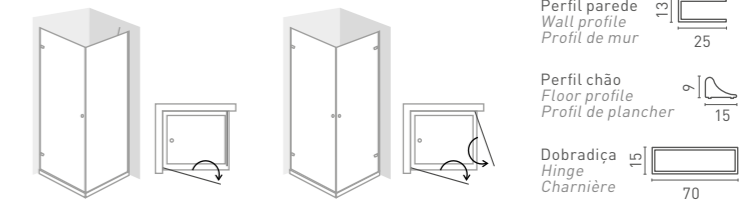

- A movable door and a movable or fixed lateral panel
- Opening for the outside
- chromed brass fittings and hinges
- Metalized aluminum profiles
- Standard height 195cm
- Tempered glass of 6mm choose plain, listed or bleak
- Magnetic lock
- Mandatory measures for ordering
- Medium watertightness

- Constitué pour une porte frontale et un panel latérale fixé ou une porte
- Ouverture vers l'extérieur
- Accessoires en laiton chromée
- Profil d'aluminium métallisé
- Hauteur standard 195cm
- Verre tempère de 6mm choisir plain, listé ou sombré
- Serrage magnétique
- Mesures obligatoires à la demande
- Étanchéité à l'eau moyenne



15

www.ajnoqueira.com

- Opções:
- Medidas especiais
  - Serigrafias especiais

- Options:
- Special measures
  - Special silkscreen

- Options:
- Mesures spéciales
  - Sérigraphie du verre



# NEIVA

Cabine | Cabin / Cabine

- Dois painéis fixos e duas portas
- Abertura para o exterior
- Acessórios em latão cromado
- Perfil metalizado
- Altura standard 195cm
- Vidro temperado de 6mm liso, listado ou fosco
- Fecho magnético
- Medidas exatas necessárias para encomenda
- Estanquidade média

- Two doors and two pannels
- Outside opening
- Chromed brass fittings and hinges
- Metalized aluminum profiles
- Standard height 195cm
- Tempered glass of 6mm choose plain, listed or bleak
- Magnetic lock
- Mandatory measures for ordering
- Medium watertightness

Perfil parede  
Wall profile  
Profil de mur



Perfil chão  
Floor profile  
Profil de plancher



- Constitué pour deux portes et deux Panneaux fixes
- Ouverture vers l'extérieur
- Accessoires en laiton chromée
- Profil d'aluminium métallisé
- Hauteur standard 195cm
- Verre tempère de 6mm choisir plain, listé ou sombre
- Serrage magnétique
- Mesures obligatoires à la demande
- Étanchéité à l'eau moyenne

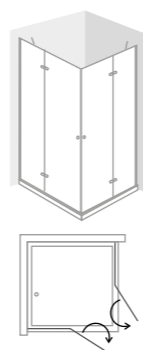

# TORPES

Cabine | Cabin / Cabine

- Dois painéis fixos e uma porta
- Abertura para o exterior
- Acessórios em latão cromado
- Perfil metalizado
- Altura standard 195cm
- Vidro temperado de 6mm liso, listado ou fosco
- Fecho magnético
- Medidas exatas necessárias para encomenda
- Estanquidade média

- Two panels and one door
- Outside opening
- Chromed brass fittings and hinges
- Metalized aluminum profiles
- Standard height 195cm
- Tempered glass of 6mm choose plain, listed or bleak
- Magnetic lock
- Mandatory measures for ordering
- Medium watertightness

Perfil parede  
Wall profile  
Profil de mur



Perfil chão  
Floor profile  
Profil de plancher



Dobradiça  
Hinge  
Charnière



- Constitué pour une porte et deux panneaux fixes
- Ouverture vers l'extérieur
- Accessoires en laiton chromée
- Profil d'aluminium métallisé
- Hauteur standard 195cm
- Verre tempère de 6mm choisir plain, listé ou sombre
- Serrage magnétique
- Mesures obligatoires à la demande
- Étanchéité à l'eau moyenne



16

- Opções:
- Medidas especiais
  - Serigrafias especiais

- Options:
- Special measures
  - Special silkscreen

- Options:
- Mesures spéciaux
  - Sérigraphie du verre



17  
www.ajnoqueira.com

- Opções:
- Medidas especiais
  - Serigrafias especiais
  - Abertura para dentro

- Options:
- Special measures
  - Special silkscreen
  - Inside opening

- Options:
- Mesures spéciaux
  - Sérigraphie du verre
  - Ouverture vers l'intérieur



# BARRADUPLA

Cabine Dupla | Double Cabin / Cabine Double

- Dois painéis fixos e duas portas
- Abertura para o exterior ou interior
- Acessórios em latão cromado
- Perfil polido ou lacado a branco
- Altura standard 185cm
- Vidro temperado de 6mm  
liso, listado ou fosco
- Fecho magnético
- Medidas exatas necessárias para encomenda
- Estanquidade média

- Two panels and two doors
- Outside or inside opening
- Chromed brass fittings
- Lacquered in white or polished  
aluminium profiles
- Standard height 185cm
- Tempered glass of 6mm  
choose plain, listed or bleak
- Magnetic lock
- Mandatory measures for ordering
- Medium watertightness

- Constitué pour deux portes et deux  
panneaux fixes
- Ouverture vers l'extérieur ou l'intérieur
- Accessoires en laiton chromée
- Profil d'aluminium polie ou  
laquée en blanc
- Hauteur standard 185cm
- Verre tempère de 6mm  
choisir plain, listé ou sombre
- Serrage magnétique
- Mesures obligatoires à la demande
- Étanchéité à l'eau moyenne

18

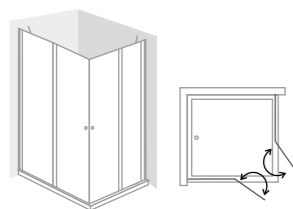

Perfil parede  
Wall profile  
Profil de mur

Perfil chão  
Floor profile  
Profil de plancher

25

15

#### Opções:

- Medidas especiais
- Serigrafias especiais

#### Options:

- Special measures
- Special silkscreen

#### Options:

- Mesures spéciales
- Sérigraphie du verre

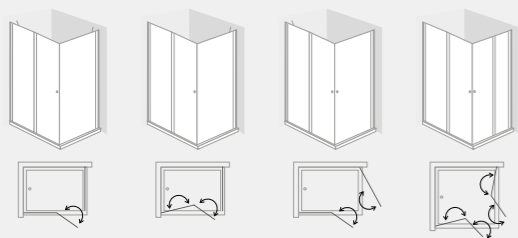

# BUARCOS

Cabine 4 Portas | 4 Doors Cabin / Cabine 4 Portes

- Constituído por duas portas divididas ao meio em altura
- Abertura para o exterior ou interior e independente das 4 portas
- Acessórios em latão cromado
- Perfil polido ou lacado a branco
- Altura standard 185cm
- Vidro temperado de 6mm – liso, listado ou fosco
- Fecho magnético
- Medidas exatas necessárias para encomenda
- Estanquidade baixa

- Made of four doors positioned two by two in the vertical position
- Outside or inside opening and individual opening of each door
- Chromed brass fittings
- Lacquered in white or polished aluminium profiles
- Standard height 185cm
- Tempered glass of 6mm choose plain, listed or bleak
- Magnetic lock
- Mandatory measures for ordering
- Low watertightness

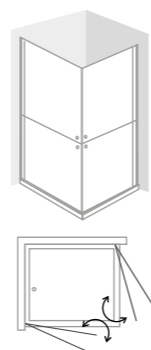

- Constitué pour quatre portes positionne deux à deux sur la verticale
- Ouverture vers l'extérieur ou l'intérieur et indépendant des quatre portes
- Accessoires en laiton chromée
- Profil d'aluminium polie ou laquée en blanc
- Hauteur standard 185cm
- Verre tempère de 6mm choisir plain, listé ou sombre
- Serrage magnétique
- Mesures obligatoires à la demande
- Faible étanchéité

# BARRA

Cabine | Cabin / Cabine

- Constituído por uma porta e um painel ou por duas portas
- Abertura para o exterior
- Acessórios em latão cromado
- Perfil polido ou lacado a branco
- Altura standard 185cm
- Vidro temperado de 6mm liso, listado ou fosco
- Fecho magnético
- Medidas exatas necessárias para encomenda
- Estanquidade média

- Made of two doors or one panel and one door
- Outside opening
- Chromed brass fittings
- Lacquered in white or polished aluminium profiles
- Standard height 185cm
- Tempered glass of 6mm choose plain, listed or bleak
- Magnetic lock
- Mandatory measures for ordering
- Medium watertightness

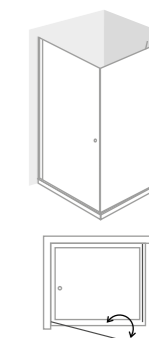

- Constitué pour deux portes ou un panel et une porte
- Ouverture vers l'extérieur
- Accessoires en laiton chromée
- Profil d'aluminium polie ou laquée en blanc
- Hauteur standard 185cm
- Verre tempère de 6mm choisir plain, listé ou sombre
- Serrage magnétique
- Mesures obligatoires à la demande
- Étanchéité à l'eau moyenne



20

- Opções:
- Medidas especiais
  - Serigrafias especiais

- Options:
- Special measures
  - Special silkscreen

- Options:
- Mesures spéciaux
  - Sérigraphie du verre



21

www.ajnoqueira.com

- Opções:
- Medidas especiais
  - Serigrafias especiais

- Options:
- Special measures
  - Special silkscreen

- Options:
- Mesures spéciaux
  - Sérigraphie du verre

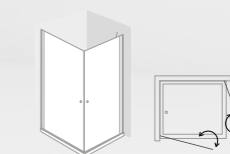

# AREÃO

Cabine | Cabin / Cabine

- Constituído por duas portas e dois painéis fixos
- Abertura de correr
- Acessórios cromados
- Perfil cromado ou lacado a branco
- Altura standard 195cm
- Vidro temperado de **6mm** liso, listado ou fosco
- Fecho magnético
- Quadrada ou retangular
- Medidas exatas necessárias para encomenda
- Estanquidade alta

- Made of two doors and two panels
- Sliding opening
- Chromed fittings
- Chromed or lacquered in white aluminium profiles
- Standard height 195cm
- Tempered plain glass of **6mm**, listed or bleak
- Magnetic lock
- Squared or rectangular
- Mandatory measures for ordering
- High watertightness

- Constitué pour deux portes et deux panneaux
- Ouverture coulissante
- Accessoires chromée
- Profil d'aluminium chromé ou laqué en blanc
- Hauteur standard 195cm
- Verre tempère de **6mm**, listé ou sombre
- Serrage magnétique
- Carré ou rectangulaire
- Mesures obligatoires à la demande
- Haute étanchéité

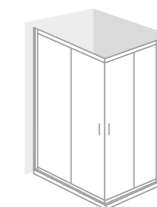

- Opções:
- Medidas especiais
  - Serigrafias especiais

- Options:
- Special measures
  - Special silkscreen

- Options:
- Mesures spéciaux
  - Sérigraphie du verre

# COMPORTA

Cabine | Cabin / Cabine

- Constituído por duas portas e dois painéis fixos
- Abertura de correr
- Acessórios cromados
- Perfil cromado ou lacado a branco
- Altura standard 195cm
- Vidro temperado de 6mm liso, listado ou fosco
- Fecho magnético
- Quadrada ou retangular
- Medidas exatas necessárias para encomenda
- Estantidade alta

- Made of two doors and two panels
- Sliding opening
- Chromed fittings
- Chromed or lacquered in white aluminium profiles
- Standard height 195cm
- Tempered plain glass of 6mm, listed or bleak
- Magnetic lock
- Squared or rectangular
- Mandatory measures for ordering
- High watertightness

- Constitué pour deux portes et deux panneaux
- Ouverture coulissante
- Accessoires chromée
- Profil d'aluminium chromé ou laqué en blanc
- Hauteur standard 195cm
- Verre tempère de 6mm, listé ou sombre
- Serrage magnétique
- Carré ou rectangulaire
- Mesures obligatoires à la demande
- Haute étanchéité

24

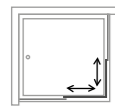
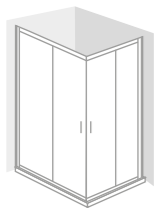

Perfil parede  
Wall profile  
Profil de mur



Perfil chão  
Floor profile  
Profil de plancher

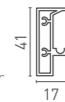

Opções:

- Medidas especiais
- Serigrafias especiais

Options:

- Special measures
- Special silkscreen

Options:

- Mesures spéciaux
- Sérigraphie du verre



# TAVIRA

Cabine | Cabin / Cabine

- Constituído por duas portas e dois painéis fixos
- Abertura de correr
- Acessórios cromados
- Perfil cromado ou lacado a branco
- Altura standard 195cm
- Vidro temperado de **6mm** liso, listado ou fosco
- Fecho magnético
- Quadrada ou retangular
- Medidas exatas necessárias para encomenda
- Estanquidade alta

- Made of two doors and two panels
- Sliding opening
- Chromed fittings
- Chromed or lacquered in white aluminium profiles
- Standard height 195cm
- Tempered plain glass of **6mm**, listed or bleak
- Magnetic lock
- Squared or rectangular
- Mandatory measures for ordering
- High watertightness

Perfil parede  
Wall profile  
Profil de mur

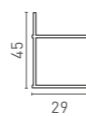

Perfil chão  
Floor profile  
Profil de plancher

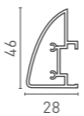

- Constitué pour deux portes et deux panneaux
- Ouverture coulissante
- Accessoires chromée
- Profil d'aluminium chromé ou laqué en blanc
- Hauteur standard 195cm
- Verre tempère de **6mm**, listé ou sombré
- Serrage magnétique
- Carré ou rectangulaire
- Mesures obligatoires à la demande
- Haute étanchéité

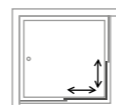
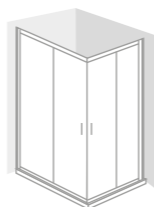

# OURA

Cabine | Cabin / Cabine

- Constituído por duas portas e dois painéis fixos
- Abertura de correr
- Acessórios cromados
- Perfil cromado ou lacado a branco
- Altura standard 195cm
- Vidro temperado de **6mm** liso ou fosco
- Fecho magnético
- Redonda
- Disponível para medidas de 80cm e 90cm
- Estanquidade alta

- Made of two doors and two panels
- Sliding opening
- Chromed fittings
- Chromed or lacquered in white aluminium profiles
- Standard height 195cm
- Tempered plain glass of **6mm** or bleak
- Magnetic lock
- Round
- Measures of 80cm or 90cm
- High watertightness

Perfil parede  
Wall profile  
Profil de mur



Perfil chão  
Floor profile  
Profil de plancher



- Constitué pour deux portes et deux panneaux
- Ouverture coulissante
- Accessoires chromée
- Profil d'aluminium chromé ou laqué en blanc
- Hauteur standard 195cm
- Verre tempère de **6mm** ou sombré
- Serrage magnétique
- Ronde
- Mesure 80cm ou 90cm
- Haute étanchéité

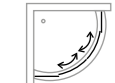
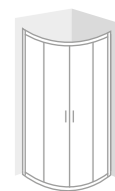

R= 500



26

- Opções:
- Medidas especiais
  - Serigrafias especiais
  - Painel lateral fixo

- Options:
- Special measures
  - Special silkscreen
  - Lateral fixed panel

- Options:
- Mesures spéciaux
  - Sérigraphie du verre
  - Panel lateral fixé

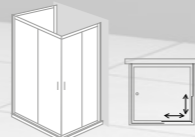

27

www.ajnoqueira.com

- Opções:
- Serigrafias especiais

- Options:
- Special silkscreen

- Options:
- Sérigraphie du verre

# NOG

Cabine | Cabin / Cabine

- Constituído por duas portas e dois painéis fixos
- Abertura de correr
- Perfil polido ou lacado a branco
- Altura standard 185cm
- Vidro temperado de 4mm liso, listado ou fosco
- Ou em acrílico 2mm "aqua viva cristal"
- Borracha vedação entre portas
- Quadrada ou rectangular
- Medidas standard de 600mm a 140cm
- Reversível
- Estanquidade alta

- Made of two doors and two panels
- Sliding opening
- Polished or lacquered in white aluminium profiles
- Standard height 185cm
- Tempered glass of 4mm choose plain, listed or bleak
- Or 2mm acrylic glass "aqua viva cristal"
- Robbers sealing between doors
- Squared or rectangular
- Standard measures of 600mm to 140cm
- Reversible
- High watertightness

Perfil parede  
Wall profile  
Profil de mur

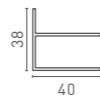

Perfil chão  
Floor profile  
Profil de plancher



- Constitué pour deux portes et deux panneaux
- Ouverture coulissante
- Profil d'aluminium poli ou laqué en blanc
- Hauteur standard 185cm
- Verre tempère de 4mm choisir plain, listé ou sombre
- Ou verre acrylique de 2mm "aqua viva cristal"
- D'étanchéité en caoutchouc entre les ports
- Carre ou rectangulaire
- Standards mesure 600mm à 140cm
- Réversible
- Haute étanchéité

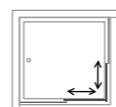
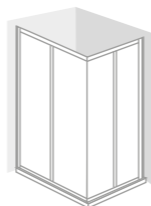

28



Opções:

- Medidas especiais
- Serigrafias especiais
- Fecho magnético
- Painel lateral fixo

Options:

- Special measures
- Special silkscreen
- Magnetic lock
- Lateral fixed panel

Options:

- Mesures spéciales
- Sérigraphie du verre
- Serrage magnétique
- Panel lateral fixé



# FOLE

Cabine | Cabin / Cabine

- Constituído por dois painéis em fole
- Abertura de correr em fole
- Perfil branco
- Altura de 185cm
- Em pvc
- Quadrada, rectangular até 120cm ou redonda de 80cm e 90cm
- Estanquidade alta

- Made of two folding panels
- Sliding and folding opening
- White profiles
- Height 185cm
- Pvc
- Squared, rectangular to 120cm or round to 80cm and 90cm
- High watertightness

- Constitué pour deux panneaux pliantes
- Ouverture coulissante et pliante
- Profil blanc
- Hauteur standard 185cm
- Pvc
- Carre, rectangulaire à 120cm ou ronde 80cm e 90cm
- Haute étanchéité

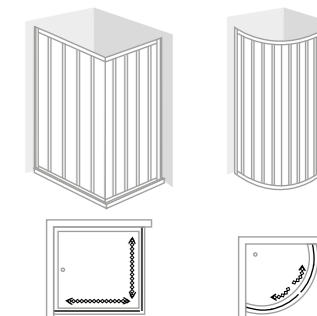

29

www.ajnoqueira.com

Opções:

- Medidas especiais
- Cores especiais

Options:

- Special measures
- Special colors

Options:

- Mesures spéciales
- Couleurs spéciales

# FRONTAIS DEDUCHE

FRONTAL SHOWER / DOUCHE FRONT







# FUNCHAL 2 FIXOS 1 PORTA COM LATERAL

Frontal com lateral  
Shower Frontal  
Front de Douche

- Uma porta fixa e uma porta de correr
- Vidro temperado de 8mm – liso ou fosco
- Altura standard de 200cm
- Largura standard entre 130cm e 170cm
- Fecho magnético
- Acessórios em aço inoxidável
- Guia e vedante na base
- Medidas exatas necessárias para encomenda
- Identificar a posição da porta face ao lateral
- Estanquidade média

- One fixed panel and one sliding door
- Tempered 8mm glass choose plain or bleak
- Standard height of 200cm
- Standard width between 130cm and 170cm
- Magnetic lock
- Stainless steel fittings
- Sliding guides washer on the base
- Mandatory measures for ordering
- Identify the position of the door to the lateral part
- Medium watertightness

- Constitué pour un panel coulissant et un panel fixe
- Verre tempéré de 8mm choisir plain ou sombré
- Hauteur standard de 200cm
- Largeur standard entre 130cm et 170cm
- Serrage magnétique
- Composants en acier inox
- Coulisse à la base
- Mesures obligatoires à la demande
- Identifier la position de la porte à la partie latérale
- Étanchéité à l'eau moyenne



Perfil parede  
Wall profile  
Profil de mur

Perfil chão  
Floor profile  
Profil de plancher

- Opções:
- Medidas especiais
  - Serigrafias especiais
  - Painel lateral fixo

- Options:
- Special measures
  - Special silkscreen
  - Fixed side panel

- Options:
- Mesures spéciales
  - Sérigraphie du verre
  - Panel latérale fixé

# FUNCHAL 1 FIXO 1 PORTA

Frontal | Shower Frontal / Front de Douche

- Uma porta fixa e uma porta de correr
- Vidro temperado de 8mm – liso ou fosco
- Altura standard de 200cm
- Perfil metalizado
- Largura standard entre 130cm e 200cm
- Fecho magnético
- Acessórios em aço inoxidável
- Guia e vedante na base
- Identificar a posição da porta
- Estanquidade média

- One fixed panel and one sliding door
- Tempered 8mm glass choose plain or bleak
- Standard height of 200cm
- Metalized aluminum profiles
- Standard width between 130cm and 200cm
- Magnetic lock
- Stainless steel fittings
- Sliding guides washer on the base
- Identify the position of the door
- Medium watertightness

Perfil parede  
Wall profile  
Profil de mur



Perfil chão  
Floor profile  
Profil de plancher



- Constitué pour un panel coulissant et un panel fixe
- Verre tempéré de 8mm - choisir plain ou sombre
- Hauteur standard de 200cm
- Profil d'aluminium métallisé
- Largeur standard entre 130cm et 200cm
- Serrage magnétique
- Composants en acier inox
- Coulisse à là base
- Identifier la position de la porte
- Étanchéité à l'eau moyenne



# FAIAL 2 FIXOS 2 PORTAS

Frontal | Shower Frontal / Front de Douche

- Duas porta fixas e duas portas de correr
- Vidro temperado de 8mm – liso ou fosco
- Altura standard de 200cm
- Perfil metalizado
- Largura standard entre 160cm e 220cm
- Fecho magnético
- Acessórios em aço inoxidável
- Roleta inferior na porta
- Guia e vedante na base
- Estanquidade média

- Two fixed panels and two sliding doors
- Tempered 8mm glass choose plain or bleak
- Standard height of 200cm
- Metalized aluminum profiles
- Standard width between 160cm and 220cm
- Magnetic lock
- Stainless steel fittings
- Bottom door roulette
- Sliding guides washer on the base
- Medium watertightness

Perfil parede  
Wall profile  
Profil de mur



Perfil chão  
Floor profile  
Profil de plancher



- Constitué pour deux panneaux coulissant et deux panneaux fixe
- Verre tempéré de 8mm - choisir plain ou sombre
- Hauteur standard de 200cm
- Profil d'aluminium métallisé
- Largeur standard entre 160cm et 220cm
- Serrage magnétique
- Composants en acier inox
- Roulette de porte inférieure
- Coulisse à là base
- Étanchéité à l'eau moyenne

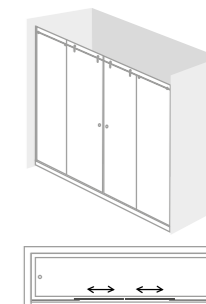

34



www.ajnoqueira.com



- Opções:
- Medidas especiais
  - Serigrafias especiais

- Options:
- Special measures
  - Special silkscreen

- Options:
- Mesures spéciaux
  - Sérigraphie du verre

# GALÉ 1 FIXO 1 PORTA

Frontal | Shower Frontal / Front de Douche

- Uma porta fixa e uma porta de correr
- Vidro temperado de 8mm – liso ou fosco
- Altura standard de 200cm
- Perfil metalizado
- Largura standard entre 130cm e 190mm
- Fecho magnético
- Acessórios em aço inoxidável
- Roleta inferior de porta
- Guia e vedante na base
- Identificar a posição da porta
- Estanquidade média

- One fixed panel and one sliding door
- Tempered 8mm glass choose plain or bleak
- Standard height of 200cm
- Metalized aluminum profiles
- Standard width between 130cm and 190mm
- Magnetic lock
- Stainless steel fittings
- Bottom door roulette
- Sliding guides washer on the base
- Identify the position of the door
- Medium watertightness

Perfil parede  
Wall profile  
Profil de mur



Perfil chão  
Floor profile  
Profil de plancher



- Constitué pour un panel coulissant et un panel fixe
- Verre tempéré de 8mm - choisir plain ou sombre
- Hauteur standard de 200cm
- Profil d'aluminium métallisé
- Largeur standard entre 130cm et 190mm
- Serrage magnétique
- Composants en acier inox
- Roulette de porte inférieure
- Coulisse à la base
- Identifier la position de la porte
- Étanchéité à l'eau moyenne



Opções:

- Medidas especiais
- Serigrafias especiais

Options:

- Special measures
- Special silkscreen

Options:

- Mesures spéciales
- Sérigraphie du verre

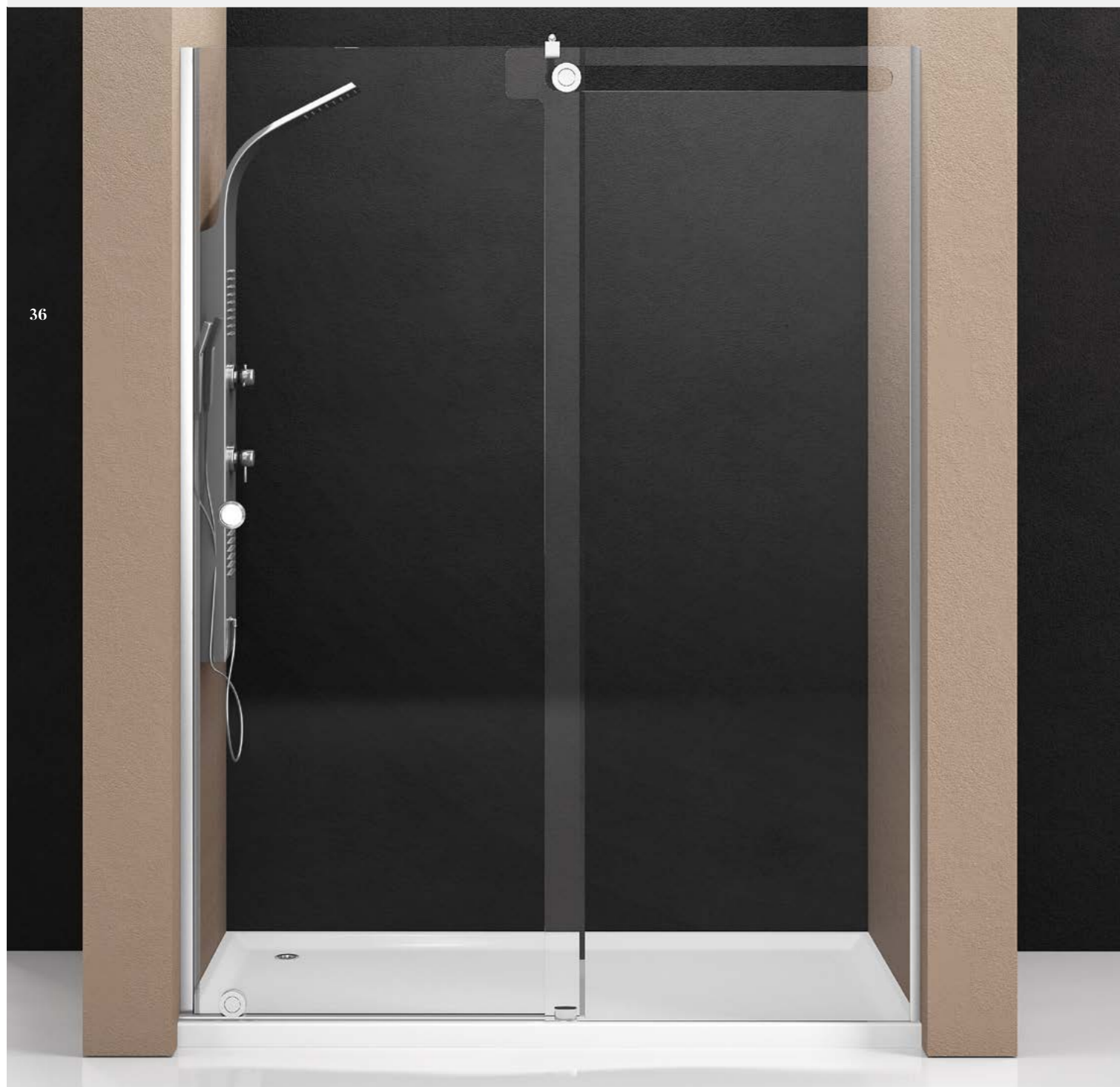

36

# GALÉ 2 FIXOS 1 PORTA COM LATERAL

Frontal com lateral | Shower Frontal / Front de Douche

- Uma porta fixa e uma porta de correr
- Vidro temperado de 8mm – liso ou fosco
- Altura standard de 200cm
- Perfil metalizado
- Largura standard entre 130cm e 170cm
- Fecho magnético
- Acessórios em aço inoxidável
- Roleta inferior de porta
- Guia e vedante na base
- Identificar a posição da porta
- Estanquidade média

- One fixed panel and one sliding door
- Tempered 8mm glass choose plain or bleak
- Standard height of 200cm
- Metalized aluminum profiles
- Standard width between 130cm and 170cm
- Magnetic lock
- Stainless steel fittings
- Bottom door roulette
- Sliding guides washer on the base
- Identify the position of the door
- Medium watertightness

Perfil parede  
Wall profile  
Profil de mur



Perfil chão  
Floor profile  
Profil de plancher



- Constitué pour un panel coulissant et un panel fixe
- Verre tempéré de 8mm - choisir plain ou sombre
- Hauteur standard de 200cm
- Profil d'aluminium métallisé
- Largeur standard entre 130cm et 170cm
- Serrage magnétique
- Composants en acier inox
- Roulette de porte inférieure
- Coulisse à la base
- Identifier la position de la porte
- Étanchéité à l'eau moyenne

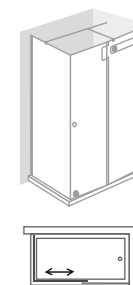

37

www.ajnoqueira.com

Opções:

- Medidas especiais
- Serigrafias especiais

Options:

- Special measures
- Special silkscreen

Options:

- Mesures spéciales
- Sérigraphie du verre

# FALÉSIA 2 FIXOS 1 PORTA

Frontal | Shower Frontal / Front de Douche

- Constituído por dois painéis fixos e uma porta de abrir para o exterior
- Acessórios em latão cromado e aço inoxidável
- Perfil metalizado
- Largura até 200cm
- Altura standard 200cm
- Vidro temperado de 6mm – liso, listado ou fosco
- Fecho magnético
- Medidas exatas necessárias para encomenda
- Estanquidade média

- Front panel with two fixed panels and one opening door for the outside
- Chromed brass and stainless steel fittings and hinges
- Metalized aluminum profiles
- Width up to 200cm
- Standard height 200cm
- Tempered glass of 6mm choose plain, listed or bleak
- Magnetic lock
- Mandatory measures for ordering
- Medium watertightness

Perfil parede  
Wall profile  
Profil de mur



Perfil chão  
Floor profile  
Profil de plancher

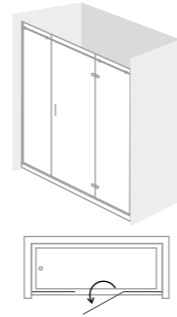

- Panel frontal constitué pour deux panneaux fixes et un porte d'ouverture vers l'extérieur
- Accessoires en laiton chromée et en acier inox
- Profil d'aluminium métallisé
- Largeur jusqu'à 200cm
- Hauteur standard 200cm
- Verre tempère de 6mm choisir plain, listé ou sombre
- Serrage magnétique
- Mesures obligatoires à la demande
- Étanchéité à l'eau moyenne

# FALÉSIA 2 FIXOS 2 PORTAS

Frontal | Shower Frontal / Front de Douche

- Constituído por dois painéis fixos e duas portas de abrir para o exterior
- Acessórios em latão cromado e aço inoxidável
- Perfil metalizado
- Largura até 260cm
- Altura standard 200cm
- Vidro temperado de 6mm – liso, listado ou fosco
- Fecho magnético
- Medidas exatas necessárias para encomenda
- Estanquidade média

- Front panel with two fixed panels and two opening doors for the outside
- Chromed brass and stainless steel fittings and hinges
- Metalized aluminum profiles
- Width up to 260cm
- Standard height 200cm
- Tempered glass of 6mm choose plain, listed or bleak
- Magnetic lock
- Mandatory measures for ordering
- Medium watertightness

Perfil parede  
Wall profile  
Profil de mur



Perfil chão  
Floor profile  
Profil de plancher

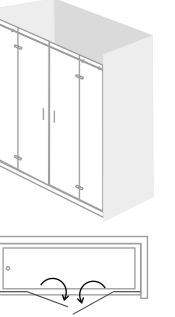

- Panel frontal constitué pour deux panneaux fixes et deux portes d'ouverture vers l'extérieur
- Accessoires en laiton chromée et en acier inox
- Profil d'aluminium métallisé
- Largeur jusqu'à 200cm
- Hauteur standard 260cm
- Verre tempère de 6mm choisir plain, listé ou sombre
- Serrage magnétique
- Mesures obligatoires à la demande
- Étanchéité à l'eau moyenne

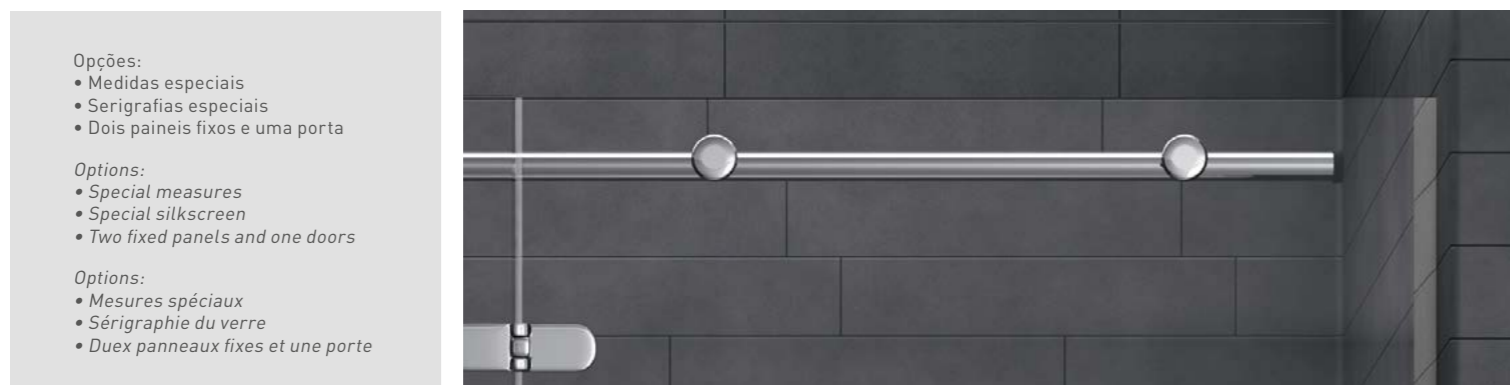

- Opções:
- Medidas especiais
  - Serigrafias especiais
  - Dois painéis fixos e uma porta

- Options:
- Special measures
  - Special silkscreen
  - Two fixed panels and one doors

- Options:
- Mesures spéciaux
  - Sérigraphie du verre
  - Deux panneaux fixes et une porte



# AFURADA

1 FIXO  
1 PORTA

Frontal | Shower Frontal / Front de Douche

- Um painel fixo e uma porta de abertura para o exterior
- Acessórios em latão cromado
- Perfil metalizado
- Largura até 160cm
- Altura standard 195cm
- Vidro temperado de 6mm liso, listado ou fosco
- Fecho magnético
- Medidas exatas necessárias para encomenda
- Estanquidade média

- Fixed panel and a opening door for the outside
- Chromed brass fittings and hinges
- Metalized aluminum profiles
- Width up to 160cm
- Standard height 195cm
- Tempered glass of 6mm choose plain, listed or bleak
- Magnetic lock
- Mandatory measures for ordering
- Medium watertightness

- Constitué pour une porte frontale d'ouverture vers l'extérieur et un panel fixé
- Accessoires en laiton chromée
- Profil d'aluminium métallisé
- Largeur jusqu'à 160cm
- Hauteur standard 195cm
- Verre tempère de 6mm choisir plain, listé ou sombré
- Serrage magnétique
- Mesures obligatoires à la demande
- Étanchéité à l'eau moyenne

40

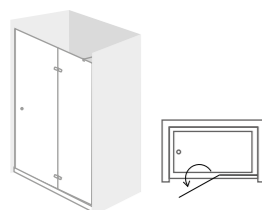

Perfil parede  
Wall profile  
Profil de mur



Perfil chão  
Floor profile  
Profil de plancher



#### Opções:

- Medidas especiais
- Serigrafias especiais
- Abertura para dentro

#### Options:

- Special measures
- Special silkscreen
- Inside opening

#### Options:

- Mesures spéciales
- Sérigraphie du verre
- Ouverture vers l'intérieur



41

www.ajnoqueira.com

# ERICEIRA

## 1 FIXO 1 PORTA

Frontal | Shower Frontal / Front de Douche

- Um painel fixo e uma porta de abertura para o exterior
- Acessórios em latão cromado
- Perfil metalizado
- Largura até 160cm
- Altura standard 195cm
- Vidro temperado de 6mm liso, listado ou fosco
- Fecho magnético
- Medidas exatas necessárias para encomenda
- Estanquidade média

- Fixed panel and a opening door for the outside
- Chromed brass fittings and hinges
- Metalized aluminum profiles
- Width up to 160cm
- Standard height 195cm
- Tempered glass of 6mm choose plain, listed or bleak
- Magnetic lock
- Mandatory measures for ordering
- Medium watertightness

- Constitué pour une porte frontale d'ouverture vers l'extérieur et un panel fixé
- Accessoires en laiton chromée
- Profil d'aluminium métallisé
- Largeur jusqu'à 160cm
- Hauteur standard 195cm
- Verre tempère de 6mm choisir plain, listé ou sombre
- Serrage magnétique
- Mesures obligatoires à la demande
- Étanchéité à l'eau moyenne

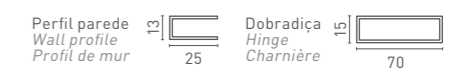
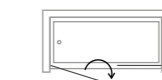
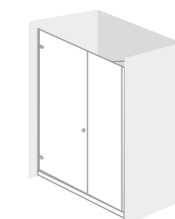

- Opções:
- Medidas especiais
  - Serigrafias especiais
  - Abertura para dentro

- Options:
- Special measures
  - Special silkscreen
  - Inside opening

- Options:
- Mesures spéciaux
  - Sérigraphie du verre
  - Ouverture vers l'intérieur

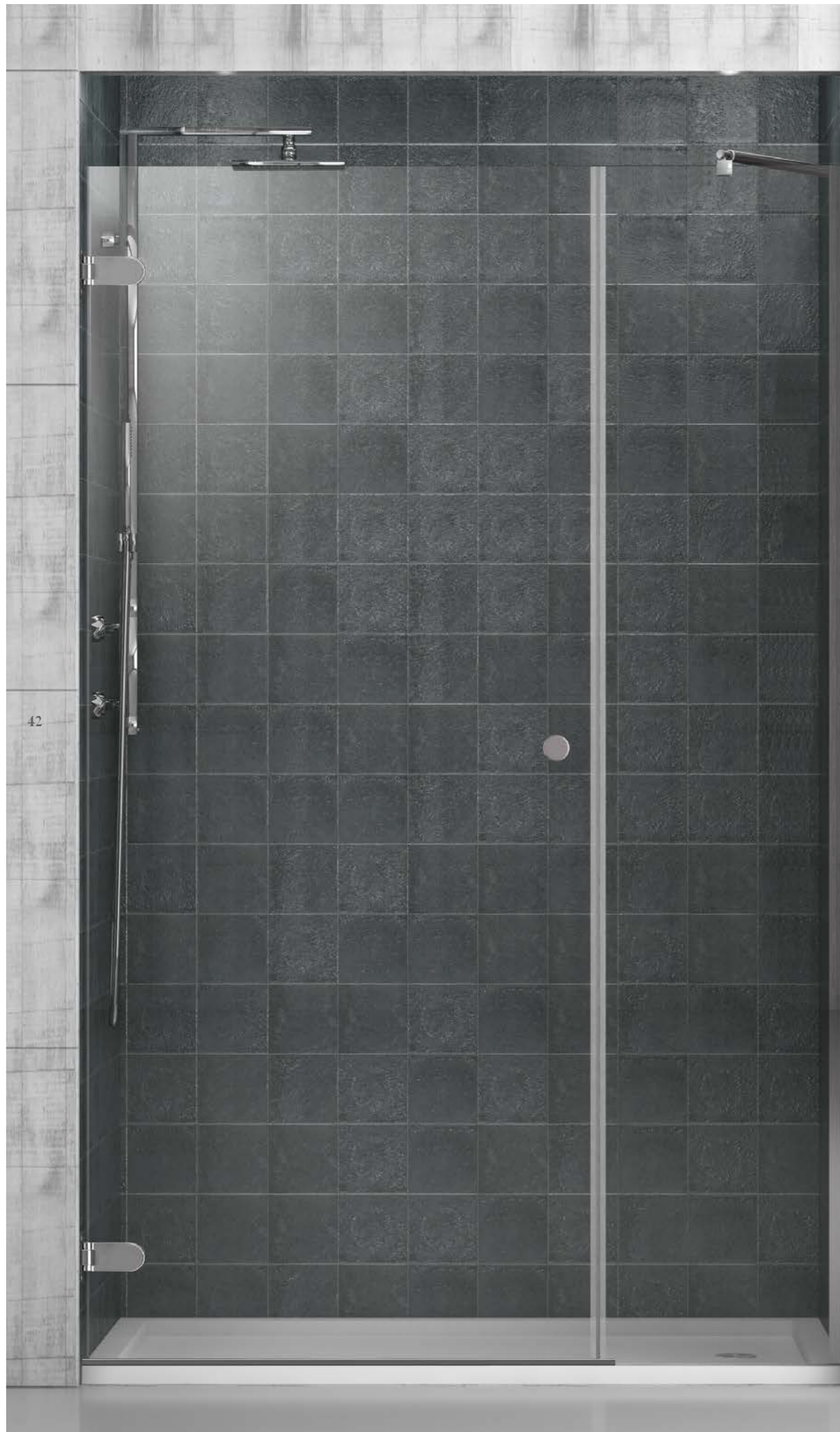

# CARVOEIRO

## 1 PORTA

Frontal | Shower Frontal / Front de Douche

- Um vidro fixo e duas portas
- Abertura para o interior
- Acessórios em latão cromado
- Perfil metalizado
- Largura até 100cm
- Altura standard 195cm
- Vidro temperado de 6mm liso, listado ou fosco
- Fecho magnético
- Medidas exatas necessárias para encomenda
- Estanquidade baixa

- One fixed glass and two doors
- Opens to the inside
- Chromed brass fittings and hinges
- Metalized aluminum profiles
- Width up to 100cm
- Standard height 195cm
- Tempered glass of 6mm choose plain, listed or bleak
- Magnetic lock
- Mandatory measures for ordering
- Low watertightness

Perfil parede  
Wall profile  
Profil de mur



Dobradiça  
Hinge  
Charnière



Perfil chão  
Floor profile  
Profil de plancher



- Constituído para duas portas e um vidro fixo
- Ouverture vers l'intérieur
- Accessoires en laiton chromée
- Profil d'aluminium métallisé
- Largeur jusqu'à 100cm
- Hauteur standard 195cm
- Verre tempère de 6mm choisir plain, listé ou sombré
- Serrage magnétique
- Mesures obligatoires à la demande
- Étanchéité faible

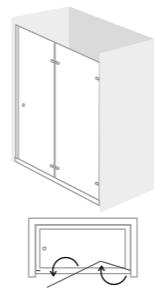

# LAGOS

## 2 PORTAS

Frontal banheira e base | Shower Frontal / Front de Douche

- Constituído por duas portas
- Abertura para o exterior
- Acessórios em latão cromado
- Altura standard de base 195cm e banheira 140cm
- Vidro temperado de 6mm liso, listado ou fosco
- Fecho magnético
- Medidas exatas necessárias para encomenda
- Estanquidade média

- Made with two doors
- Outside opening
- Chromed brass fittings and hinges
- Standard height of base 195cm and bath 140cm
- Tempered glass of 6mm choose plain, listed or bleak
- Magnetic lock
- Mandatory measures for ordering
- Medium watertightness

Perfil parede  
Wall profile  
Profil de mur



Perfil chão  
Floor profile  
Profil de plancher



- Constituído para duas portas
- Ouverture vers l'extérieur
- Accessoires en laiton chromée
- Hauteur standard de base 195cm et baignoire 140cm
- Verre tempère de 6mm choisir plain, listé ou sombré
- Serrage magnétique
- Mesures obligatoires à la demande
- Étanchéité à l'eau moyenne



44

- Opções:
- Medidas especiais
  - Serigrafias especiais
  - Painel lateral fixo
- Options:
- Special measures
  - Special silkscreen
  - Lateral fixed panel
- Options:
- Mesures spéciaux
  - Sérigraphie du verre
  - Panel lateral fixé

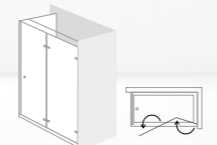

45

- Opções:
- Medidas especiais
  - Serigrafias especiais
  - Abertura para dentro
- Options:
- Special measures
  - Special silkscreen
  - Inside opening
- Options:
- Mesures spéciaux
  - Sérigraphie du verre
  - Ouverture vers l'intérieur



www.ajnoqueira.com

# TORREIRA 2 FIXOS 1 PORTA

Frontal | Shower Frontal / Front de Douche

- Dois painéis fixos e uma porta
- Abertura para o exterior
- Acessórios em latão cromado
- Perfil metalizado
- Largura até 180cm
- Altura standard 195cm
- Vidro temperado de 6mm liso, listado ou fosco
- Fecho magnético
- Medidas exatas necessárias para encomenda
- Estanquidade alta

- Two panels and one door
- Outside opening
- Chromed brass fittings and hinges
- Metalized aluminum profiles
- Width up to 180cm
- Standard height 195cm
- Tempered glass of 6mm choose plain, listed or bleak
- Magnetic lock
- Mandatory measures for ordering
- High watertightness

- Constitué pour une porte et deux panneaux fixes
- Ouverture vers l'extérieur
- Accessoires en laiton chromée
- Profil d'aluminium métallisé
- Largeur jusqu'à 180cm
- Hauteur standard 195cm
- Verre tempère de 6mm choisir plain, listé ou sombre
- Serrage magnétique
- Mesures obligatoires à la demande
- Haute étanchéité

Perfil parede  
Wall profile  
Profil de mur

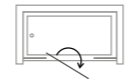

# SAGRES 2 PORTAS

Frontal banheira e base | Shower Frontal / Front de Douche

- Constituído por duas portas
- Abertura para o exterior ou interior ao centro
- Perfil polido ou lacado a branco
- Altura standard 185cm
- Largura até 140cm
- Vidro temperado de 6mm liso, listado ou fosco
- Fecho magnético
- Medidas exatas necessárias para encomenda
- Estanquidade média

- Made of two doors
- Outside or inside opening at the middle
- Lacquered in white or polished aluminium profiles
- Width up to 140cm
- Standard height 185cm
- Tempered glass of 6mm choose plain, listed or bleak
- Magnetic lock
- Mandatory measures for ordering
- Medium watertightness

- Constitué pour deux portes
- Ouverture vers l'extérieur ou l'intérieur au centre
- Profil d'aluminium polie ou laquée en blanc
- Largeur jusqu'à 140cm
- Hauteur standard 185cm
- Verre tempère de 6mm choisir plain, listé ou sombre
- Serrage magnétique
- Mesures obligatoires à la demande
- Étanchéité à l'eau moyenne

Perfil parede  
Wall profile  
Profil de mur

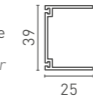

Perfil chão  
Floor profile  
Profil de plancher

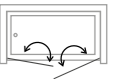

46

Opções:  
• Medidas especiais  
• Serigrafias especiais

Options:  
• Special measures  
• Special silkscreen

Options:  
• Mesures spéciaux  
• Sérigraphie du verre

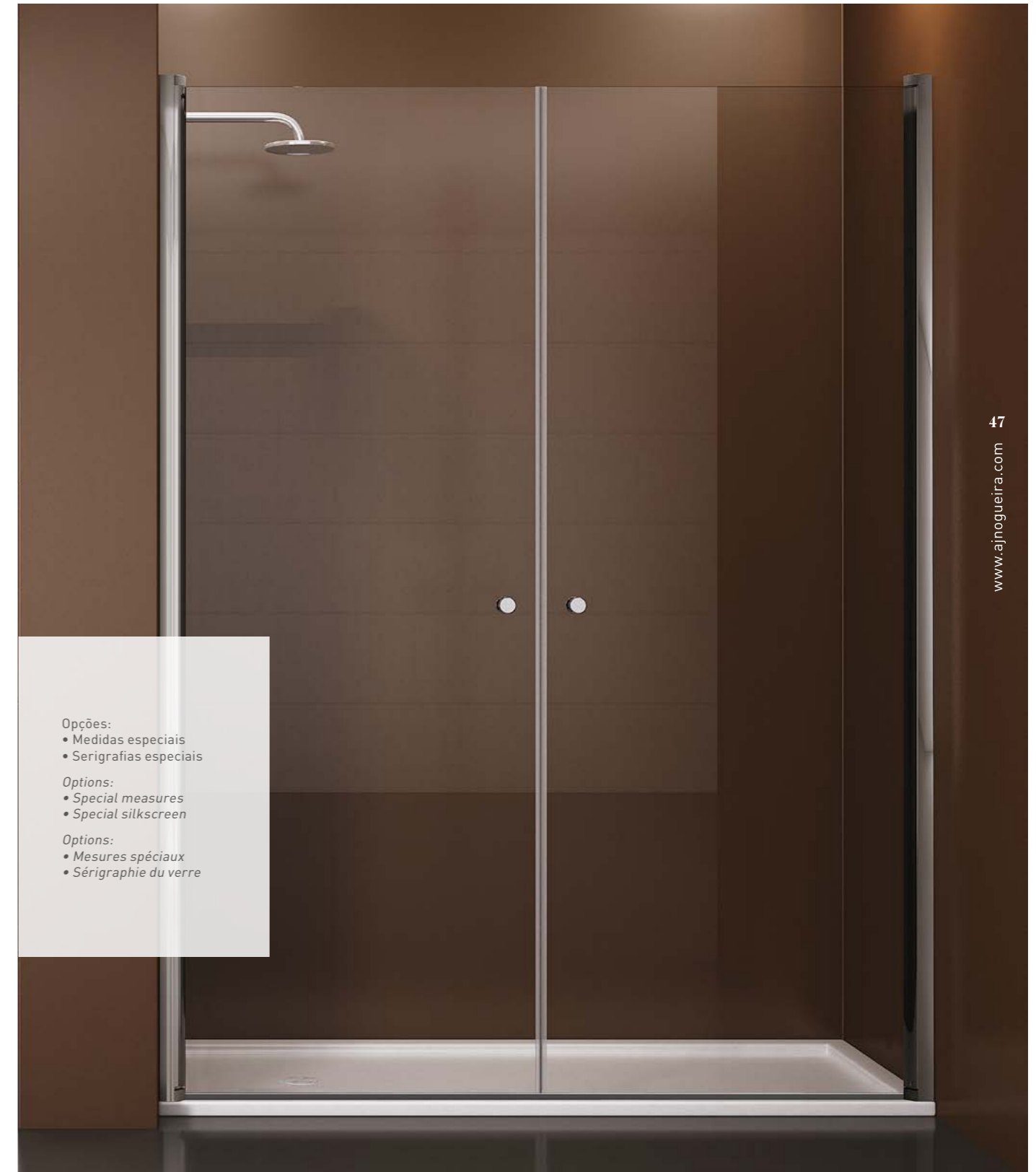

47

www.ajnogueira.com

Opções:  
• Medidas especiais  
• Serigrafias especiais

Options:  
• Special measures  
• Special silkscreen

Options:  
• Mesures spéciaux  
• Sérigraphie du verre



# PENICHE 1 FIXO 1 PORTA

Frontal | Shower Frontal / Front de Douche

- Constituído por um fixo e uma porta
- Abertura para o exterior ou interior ao centro
- Acessórios em latão cromado
- Perfil polido ou lacado a branco
- Largura até 160cm
- Altura standard 185cm
- Vidro temperado de 6mm liso, listado ou fosco
- Fecho magnético
- Medidas exatas necessárias para encomenda
- Estantiquidade média

- Made of one fixe and one door
- Outside or inside opening at the middle
- Chromed brass fittings
- Lacquered in white or polished aluminium profiles
- Width up to 160cm
- Standard height 185cm
- Tempered glass of 6mm choose plain, listed or bleak
- Magnetic lock
- Mandatory measures for ordering
- Medium watertightness

Perfil parede  
Wall profile  
Profil de mur



Perfil chão  
Floor profile  
Profil de plancher



- Constitué pour un panel fixe et un porte
- Ouverture vers l'extérieur ou l'intérieur au centre
- Accessoires en laiton chromée
- Profil d'aluminium polie ou laquée en blanc
- Largeur jusqu'à 160cm
- Hauteur standard 185cm
- Verre tempère de 6mm choisir plain, listé ou sombre
- Serrage magnétique
- Mesures obligatoires à la demande
- Étanchéité à l'eau moyenne

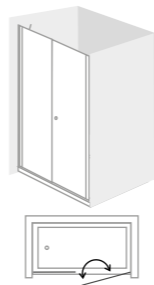

# MELIDES 1 FIXO 1 PORTA

Frontal | Shower Frontal / Front de Douche

- Constituído por um fixo e uma porta
- Abertura para o exterior ou interior à parede
- Acessórios em latão cromado
- Perfil polido ou lacado a branco
- Largura até 130cm
- Altura standard 185cm
- Vidro temperado de 6mm liso, listado ou fosco
- Fecho magnético
- Medidas exatas necessárias para encomenda
- Estantiquidade média

- Made of one fixe and one door
- Outside or inside opening to the wall side
- Chromed brass fittings
- Lacquered in white or polished aluminium profiles
- Width up to 130cm
- Standard height 185cm
- Tempered glass of 6mm choose plain, listed or bleak
- Magnetic lock
- Mandatory measures for ordering
- Medium watertightness

Perfil parede  
Wall profile  
Profil de mur



Perfil chão  
Floor profile  
Profil de plancher



- Constitué pour un panel fixe et un porte
- Ouverture vers l'extérieur ou l'intérieur à côté du paroi
- Accessoires en laiton chromée
- Profil d'aluminium polie ou laquée en blanc
- Largeur jusqu'à 130cm
- Hauteur standard 185cm
- Verre tempère de 6mm choisir plain, listé ou sombre
- Serrage magnétique
- Mesures obligatoires à la demande
- Étanchéité à l'eau moyenne

- Made of one fixe and one door
- Outside or inside opening to the wall side
- Chromed brass fittings
- Lacquered in white or polished aluminium profiles
- Width up to 130cm
- Standard height 185cm
- Tempered glass of 6mm choose plain, listed or bleak
- Magnetic lock
- Mandatory measures for ordering
- Medium watertightness

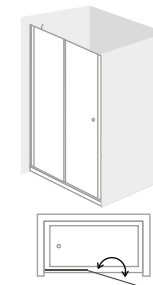

48

Opções:  
• Medidas especiais  
• Serigrafias especiais

Options:  
• Special measures  
• Special silkscreen

Options:  
• Mesures spéciaux  
• Sérigraphie du verre



49  
www.ajnoqueira.com

# GALAPOPOS 2 FIXOS 2 PORTAS

Frontal | Shower Frontal / Front de Douche

- Constituído por duas portas e dois painéis fixos
- Abertura para o exterior ou interior
- Acessórios em latão cromado
- Perfil polido ou lacado a branco
- Largura até 200cm
- Altura standard 185cm
- Vidro temperado de 6mm liso, listado ou fosco
- Fecho magnético
- Medidas exatas necessárias para encomenda
- Estanquidade média

- Made of two doors and two fixed panes
- Outside or inside opening
- Chromed brass fittings
- Lacquered in white or polished aluminium profiles
- Width up to 200cm
- Standard height 185cm
- Tempered glass of 6mm choose plain, listed or bleak
- Magnetic lock
- Mandatory measures for ordering
- Medium watertightness

- Constitué pour deux portes et deux panneaux fixes
- Ouverture vers l'extérieur ou l'intérieur
- Accessoires en laiton chromée
- Profil d'aluminium polie ou laquée en blanc
- Largeur jusqu'à 200cm
- Hauteur standard 185cm
- Verre tempère de 6mm choisir plain, listé ou sombre
- Serrage magnétique
- Mesures obligatoires à la demande
- Étanchéité à l'eau moyenne

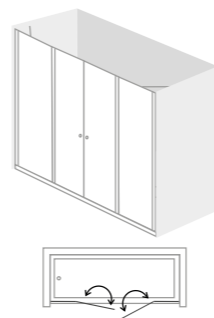

# SESIMBRA 2 FIXOS 1 PORTA

Frontal | Shower Frontal / Front de Douche

- Constituído por uma porta e dois painéis fixos
- Abertura para o exterior ou interior
- Acessórios em latão cromado
- Perfil polido ou lacado a branco
- Largura até 180cm
- Altura standard 185cm
- Vidro temperado de 6mm liso, listado ou fosco
- Fecho magnético
- Medidas exatas necessárias para encomenda
- Estanquidade média

- Made of one door and two fixed panes
- Outside or inside opening
- Chromed brass fittings
- Lacquered in white or polished aluminium profiles
- Width up to 180cm
- Standard height 185cm
- Tempered glass of 6mm choose plain, listed or bleak
- Magnetic lock
- Mandatory measures for ordering
- Medium watertightness

- Constitué pour un porte et deux panneaux fixes
- Ouverture vers l'extérieur ou l'intérieur
- Accessoires en laiton chromée
- Profil d'aluminium polie ou laquée en blanc
- Largeur jusqu'à 180cm
- Hauteur standard 185cm
- Verre tempère de 6mm choisir plain, listé ou sombre
- Serrage magnétique
- Mesures obligatoires à la demande
- Étanchéité à l'eau moyenne

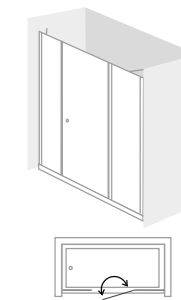

50



51

www.ajnoqueira.com

- Opções:
- Medidas especiais
  - Serigrafias especiais

- Options:
- Special measures
  - Special silkscreen

- Options:
- Mesures spéciaux
  - Sérigraphie du verre



# CAPARICA

COM LATERAL

2 FIXOS

1 PORTA

Frontal | Shower Frontal / Front de Douche

- Uma porta fixa e uma porta de correr
- Vidro temperado de 6mm – liso ou fosco
- Altura standard de 200cm
- Perfil metalizado
- Largura standard entre 130cm e 170cm
- Fecho magnético
- Acessórios em aço inoxidável
- Guia e vedante na base
- Identificar a posição da porta
- Medidas exatas necessárias para encomenda
- Estanquidade média

- One fixed panel and one sliding door
- Tempered 6mm glass choose plain or bleak
- Standard height of 200cm
- Metalized aluminum profiles
- Standard width between 130cm and 170cm
- Magnetic lock
- Stainless steel fittings
- Sliding guides washer on the base
- Identify the position of the door
- Mandatory measures for ordering
- Medium watertightness

- Constitué pour un panel coulissant et un panel fixe
- Verre tempéré de 6mm - choisir plain ou sombre
- Hauteur standard de 200cm
- Profil d'aluminium métallisé
- Largeur standard entre 130cm et 170cm
- Serrage magnétique
- Composants en acier inox
- Coulisse à la base
- Identifier la position de la porte
- Mesures obligatoires à la demande
- Étanchéité à l'eau moyenne



Perfil parede  
Wall profile  
Profil de mur



Perfil chão  
Floor profile  
Profil de plancher



# CAPARICA 1 FIXO 1 PORTA

Frontal | Shower Frontal / Front de Douche

- Uma porta fixa e uma porta de correr
- Vidro temperado de 6mm – liso ou fosco
- Altura standard de 200cm
- Perfil metalizado
- Largura standard entre 120cm e 180cm
- Fecho magnético
- Acessórios em aço inoxidável
- Guia e vedante na base
- Identificar a posição da porta
- Medidas exatas necessárias para encomenda
- Estanquidade média

- One fixed panel and one sliding door
- Tempered 6mm glass choose plain or bleak
- Standard height of 200cm
- Metalized aluminum profiles
- Standard width between 120cm and 180cm
- Magnetic lock
- Stainless steel fittings
- Sliding guides washer on the base
- Identify the position of the door
- Mandatory measures for ordering
- Medium watertightness

Perfil parede Wall profile Profil de mur 25  
 Perfil chão Floor profile Profil de plancher 15

- Constitué pour un panel coulissant et un panel fixe
- Verre tempéré de 6mm choisir plain ou sombre
- Hauteur standard de 200cm
- Profil d'aluminium métallisé
- Largeur standard entre 120cm et 180cm
- Serrage magnétique
- Composants en acier inox
- Coulisse à la base
- Identifier la position de la porte
- Mesures obligatoires à la demande
- Étanchéité à l'eau moyenne



54

Opções:  
 • Medidas especiais  
 • Serigrafias especiais

Options:  
 • Special measures  
 • Special silkscreen

Options:  
 • Mesures spéciales  
 • Sérigraphie du verre



# ATALAIA 2 FIXOS 2 PORTAS

Frontal | Shower Frontal / Front de Douche

- Duas porta fixas e duas portas de correr
- Vidro temperado de 6mm – liso ou fosco
- Altura standard de 200cm
- Perfil metalizado
- Largura standard entre 150cm e 210cm
- Fecho magnético
- Acessórios em aço inoxidável
- Guia e vedante na base
- Medidas exatas necessárias para encomenda
- Estanquidade média

- Two fixed panels and two sliding doors
- Tempered 6mm glass choose plain or bleak
- Standard height of 195cm
- Metalized aluminum profiles
- Standard width between 150cm and 210cm
- Magnetic lock
- Stainless steel fittings
- Sliding guides washer on the base
- Mandatory measures for ordering
- Medium watertightness

Perfil parede Wall profile Profil de mur 25  
 Perfil chão Floor profile Profil de plancher 15

- Constitué pour deux panneaux coulissant et deux panneaux fixe
- Verre tempéré de 6mm choisir plain ou sombre
- Hauteur standard de 195cm
- Profil d'aluminium métallisé
- Largeur standard entre 150cm et 210cm
- Serrage magnétique
- Composants en acier inox
- Coulisse à la base
- Mesures obligatoires à la demande
- Étanchéité à l'eau moyenne

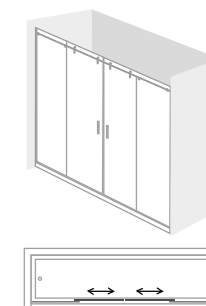

55

www.ajnoqueira.com



# GUINCHO

1 FIXO  
1 PORTA

Frontal | Shower Frontal / Front de Douche

- Constituído por um painel fixo e uma porta
- Abertura de correr
- Acessórios cromados
- Perfil cromado
- Largura até 160cm
- Altura standard 195cm
- Vidro temperado de 6mm liso
- Fecho magnético
- Medidas exatas necessárias para encomenda
- Reversível
- Estanquidade média

- Made of one sliding door and one panel
- Chromed fittings
- Chromed aluminium profiles
- Width up to 160cm
- Standard height 195cm
- Tempered plain glass of 6mm
- Magnetic lock
- Mandatory measures for ordering
- Reversible
- Medium watertightness

- Constitué pour une porte et un panneau
- Ouverture coulissante
- Accessoires chromée
- Profil d'aluminium chromé
- Largeur jusqu'à 160cm
- Hauteur standard 195cm
- Verre tempère de 6mm
- Serrage magnétique
- Mesures obligatoires à la demande
- Réversible
- Étanchéité à l'eau moyenne

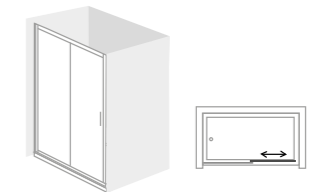

**Opções:**

- Medidas especiais
- Serigrafias especiais
- Um painel lateral

**Options:**

- Special measures
- Special silkscreen
- One lateral panel

**Options:**

- Mesures spéciales
- Sérigraphie du verre
- Un panel latéral

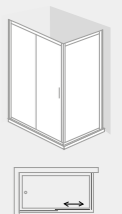



# TORRE

1 FIXO  
1 PORTA

Frontal | Shower Frontal  
Front de Douche

- Constituído por um painel fixo e uma porta
- Abertura de correr
- Acessórios cromados
- Perfil cromado
- Largura até 160cm
- Altura standard 195cm
- Vidro temperado de 6mm liso
- Fecho magnético
- Medidas exatas necessárias para encomenda
- Reversível
- Estanquidade alta

- Made of one sliding door and one panel
- Chromed fittings
- Chromed aluminium profiles
- Width up to 160cm
- Standard height 195cm
- Tempered plain glass of 6mm
- Magnetic lock
- Mandatory measures for ordering
- Reversible
- High watertightness

- Constitué pour une porte et un panneau
- Ouverture coulissante
- Accessoires chromés
- Profil d'aluminium chromé
- Largeur jusqu'à 160cm
- Hauteur standard 195cm
- Verre tempéré de 6mm
- Serrage magnétique
- Mesures obligatoires à la demande
- Réversible
- Haute étanchéité

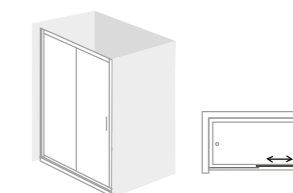

Perfil parede  
Wall profile  
Profil de mur

Perfil chão  
Floor profile  
Profil de plancher

- Opções:
- Medidas especiais
  - Serigrafias especiais

- Options:
- Special measures
  - Special silkscreen

- Options:
- Mesures spéciales
  - Sérigraphie du verre

# TOCHA

## 1 FIXO 1 PORTA

Frontal | Shower Frontal  
Front de Douche

- Constituído por um painel fixo e uma porta
- Abertura de correr
- Acessórios cromados
- Perfil cromado
- Largura até 170cm
- Altura standard 195cm
- Vidro temperado de 6mm liso
- Fecho magnético
- Medidas exatas necessárias para encomenda
- Reversível
- Estanquidade alta

- Made of one sliding door and one panel
- Chromed fittings
- Chromed aluminium profiles
- Width up to 170cm
- Standard height 195cm
- Tempered plain glass of 6mm
- Magnetic lock
- Mandatory measures for ordering
- Reversible
- High watertightness

- Constitué pour une porte et un panneau
- Ouverture coulissante
- Accessoires chromés
- Profil d'aluminium chromé
- Largeur jusqu'à 170cm
- Hauteur standard 195cm
- Verre tempéré de 6mm
- Serrage magnétique
- Mesures obligatoires à la demande
- Réversible
- Haute étanchéité

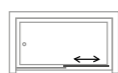

Perfil parede  
Wall profile  
Profil de mur

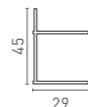

Perfil chão  
Floor profile  
Profil de plancher



### Opções:

- Medidas especiais
- Serigrafias especiais
- Um painel lateral

### Options:

- Special measures
- Special silkscreen
- One lateral panel

### Options:

- Mesures spéciales
- Sérigraphie du verre
- Un panel latéral

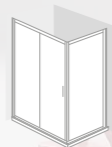

# QUAIOS 2 FIXOS 2 PORTAS

Frontal | Shower Frontal / Front de Douche

- Constituído por duas portas e dois painéis fixos
- Abertura de correr
- Acessórios cromados
- Perfil cromado
- Largura até 200cm
- Alturas standard 195cm
- Vidro liso temperado de 6mm
- Fecho magnético
- Medidas exatas necessárias para encomenda
- Reversível
- Estanquidade média

- Made of two doors and two panels
- Sliding opening
- Chromed fittings
- Chromed aluminium profiles
- Width up to 200cm
- Standard heights of 195cm
- Tempered plain glass of 6mm
- Magnetic lock
- Mandatory measures for ordering
- Reversible
- Medium watertightness

Perfil parede  
Wall profile  
Profil de mur

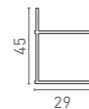

Perfil chão  
Floor profile  
Profil de plancher



- Constitué pour deux portes et deux panneaux
- Ouverture coulissante
- Accessoires chromée
- Profil d'aluminium chromé
- Largeur jusqu'à 200cm
- Hauteurs standard 195cm
- Verre tempère de 6mm
- Serrage magnétique
- Mesures obligatoires à la demande
- Réversible
- Étanchéité à l'eau moyenne

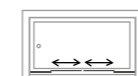

# CARVALHAL 2 FIXOS 2 PORTAS

Frontal | Shower Frontal / Front de Douche

- Constituído por duas portas e dois painéis fixos
- Abertura de correr
- Acessórios cromados
- Perfil cromado
- Largura até 200cm
- Alturas standard 195cm
- Vidro liso temperado de 6mm
- Fecho magnético
- Medidas exatas necessárias para encomenda
- Reversível
- Estanquidade alta

- Made of two doors and two panels
- Sliding opening
- Chromed fittings
- Chromed aluminium profiles
- Width up to 200cm
- Standard heights of 195cm
- Tempered plain glass of 6mm
- Magnetic lock
- Mandatory measures for ordering
- Reversible
- High watertightness

Perfil parede  
Wall profile  
Profil de mur



Perfil chão  
Floor profile  
Profil de plancher



- Constitué pour deux portes et deux panneaux
- Ouverture coulissante
- Accessoires chromée
- Profil d'aluminium chromé
- Largeur jusqu'à 200cm
- Hauteurs standard 195cm
- Verre tempère de 6mm
- Serrage magnétique
- Mesures obligatoires à la demande
- Réversible
- Haute étanchéité



62

- Opções:
- Medidas especiais
  - Serigrafias especiais
  - Um painel lateral

- Options:
- Special measures
  - Special silkscreen
  - One lateral panel

- Options:
- Mesures spéciales
  - Sérigraphie du verre
  - Un panel latéral

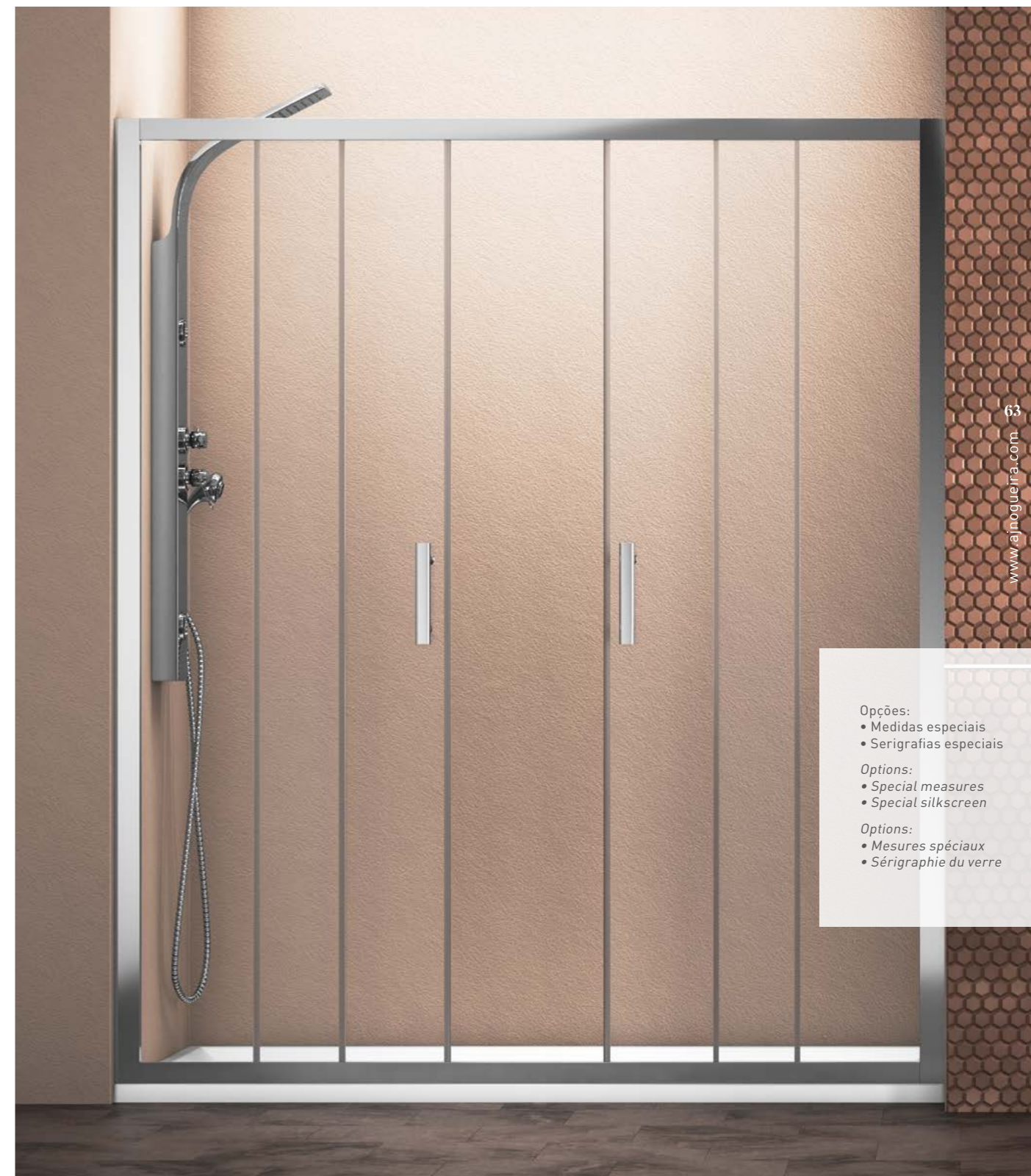
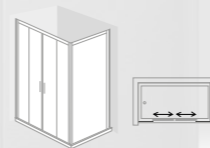

63

- Opções:
- Medidas especiais
  - Serigrafias especiais

- Options:
- Special measures
  - Special silkscreen

- Options:
- Mesures spéciales
  - Sérigraphie du verre

www.alnogueira.com



# VAGUEIRA 2 FIXOS 2 PORTAS

Frontal banheira e base | Shower Frontal  
Front de Douche

- Constituído por duas portas e dois painéis fixos
- Abertura de correr
- Acessórios cromados
- Perfil cromado
- Largura até 220cm base
- Alturas standard base 195cm e banheira 140cm
- Vidro liso temperado de 6mm
- Fecho magnético
- Medidas exatas necessárias para encomenda
- Reversível
- Estanquidade alta

- Made of two doors and two panels
- Sliding opening
- Chromed fittings
- Chromed aluminium profiles
- Width up to 200cm base
- Standard heights base 195cm and bath 140cm
- Tempered plain glass of 6mm
- Magnetic lock
- Mandatory measures for ordering
- Reversible
- High watertightness

- Constitué pour deux portes et deux panneaux
- Ouverture coulissante
- Accessoires chromée
- Profil d'aluminium chromé
- Largeur jusqu'à 200cm base
- Hauteurs standard base 195cm et baignoire 140cm
- Verre tempère de 6mm
- Serrage magnétique
- Mesures obligatoires à la demande
- Réversible
- Haute étanchéité

Perfil parede  
Wall profile  
Profil de mur



Perfil chão  
Floor profile  
Profil de plancher

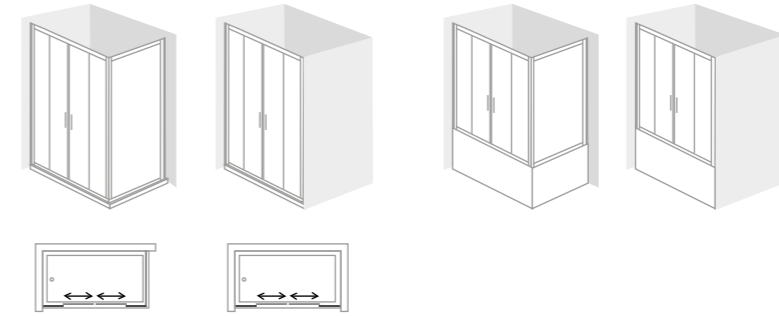
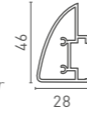

- Opções:
- Medidas especiais
  - Serigrafias especiais
  - Um painel lateral

- Options:
- Special measures
  - Special silkscreen
  - One lateral panel

- Options:
- Mesures spéciales
  - Sérigraphie du verre
  - Un panel latéral



64



65

www.ajnoqueira.com

# NOG4 2 FIXOS 2 PORTAS

Frontal 2+2 banheira e base  
2+2 Shower Frontal  
Front de Douche 2+2

- Constituído por duas portas de correr e dois painéis fixos
- Abertura central e portas de correr
- Perfil polido ou lacado a branco
- Altura standard base 185cm e banheira 140cm
- Vidro temperado de 4mm liso, listado ou fosco
- Ou em acrílico 2mm "aqua viva cristal"
- Borracha vedação entre portas
- Fecho magnético
- Medidas exatas necessárias para encomenda
- Reversível
- Estantidade alta

- Made of two doors and two panels
- Central opening and sliding doors
- Polished or lacquered in white aluminium profiles
- Standard height base 185cm and bath 140cm
- Tempered glass of 4mm choose plain, listed or bleak
- Or 2mm acrylic glass "aqua viva cristal"
- Robbers sealing between doors
- Magnetic lock
- Mandatory measures for ordering
- Reversible
- High watertightness

- Constitué pour deux portes et deux panneaux
- Ouverture centrale et des portes coulissantes
- Profil d'aluminium polie ou laqué en blanc
- Hauteur standard base 185cm et baignoire 140cm
- Verre tempère de 4mm choisir plain, listé ou sombre
- Ou verre acrylique de 2mm "aqua viva cristal"
- D'étanchéité en caoutchouc entre les ports
- Serrage magnétique
- Mesures obligatoires à la demande
- Réversible
- Haute étanchéité

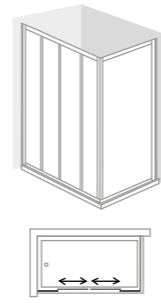
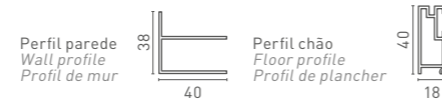

# NOG2 1 FIXO 1 PORTA

Frontal 1+1 banheira e base  
1+1 Shower Frontal  
Front de Douche 1+1

- Constituído por uma porta de correr e um painel fixo
- Abertura de correr
- Perfil polido ou lacado a branco
- Altura standard base 185cm e banheira 140cm
- Vidro temperado de 4mm liso, listado ou fosco
- Ou em acrílico 2mm "aqua viva cristal"
- Borracha vedação entre portas
- Fecho magnético
- Reversível
- Estantidade alta

- Made of one door and one panel
- Sliding opening
- Polished or lacquered in white aluminium profiles
- Standard height base 185cm and bath 140cm
- Tempered glass of 4mm Choose plain, listed or bleak
- Or 2mm acrylic glass "aqua viva cristal"
- Robbers sealing between doors
- Magnetic lock
- Reversible
- High watertightness

- Constitué pour une porte et un pannel
- Ouverture coulissante
- Profil d'aluminium polie ou laqué en blanc
- Hauteur standard base 185cm et baignoire 140cm
- Verre tempère de 4mm choisir plain, listé ou sombre
- Ou verre acrylique de 2mm "aqua viva cristal"
- D'étanchéité en caoutchouc entre les ports
- Serrage magnétique
- Réversible
- Haute étanchéité

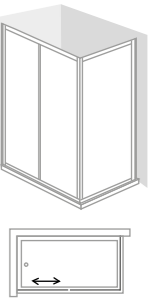
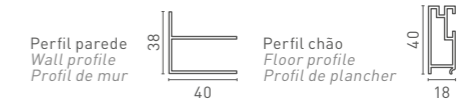

66

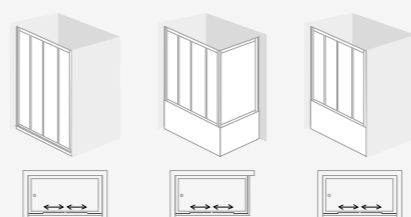

- Opções:
- Medidas especiais
  - Serigrafias especiais
  - Painel lateral fixo
- Options:
- Special measures
  - Special silkscreen
  - Lateral fixed panel
- Options:
- Mesures spéciaux
  - Sérigraphie du verre
  - Panel lateral fixé



67

www.ajnoqueira.com

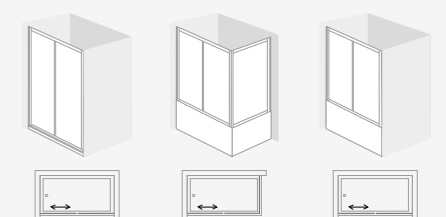

- Opções:
- Medidas especiais
  - Painel lateral fixo
- Options:
- Special measures
  - lateral fixed panel
- Options:
- Mesures spéciaux
  - Sérigraphie du verre
  - Panel lateral fixé

# EIRA 3 PORTAS

Frontal banheira e base

Shower Frontal

Front de Douche

- Constituído por três portas
- Abertura de correr
- Perfil polido ou lacado a branco
- Altura standard base 185cm e banheira 140cm
- Vidro temperado de 4mm
- liso, listado ou fosco
- Ou em acrílico 2mm "aqua viva cristal"
- Fecho magnético
- Reversível
- Estanquidade alta

- Made of three doors
- Sliding opening
- Polished or lacquered in white
- aluminium profiles
- Standard height base 185cm and bath 140cm
- Tempered glass of 4mm - choose plain, listed or bleak
- Or 2mm acrylic glass "aqua viva cristal"
- Magnetic lock
- Reversible
- High watertightness

- Constitué pour trois portes
- Ouverture coulissante
- Profil d'aluminium polie ou laqué en blanc
- Hauteur standard base 185cm et baignoire 140cm
- Verre tempère de 4mm - choisir plain, listé ou sombré
- Ou verre acrylique de 2mm "aqua viva cristal"
- Serrage magnétique
- Réversible
- Haute étanchéité

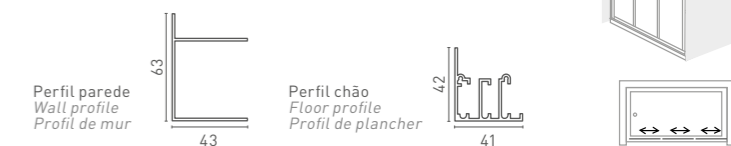

68



www.ajnoqueira.com

69

- Opções:
- Medidas especiais
  - Serigrafias especiais
  - Painel lateral fixo
- Options:
- Special measures
  - Special silkscreen
  - Lateral fixed panel
- Options:
- Mesures spéciales
  - Sérigraphie du verre
  - Panel lateral fixé

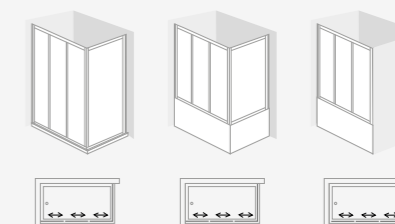

# ESTORIL 2 PORTAS

Frontal banheira e base  
Shower Frontal / Front de Douche

- Constituído por duas portas
- Abertura de correr
- Perfil polido ou lacado a branco
- Altura standard base 185cm e banheira 140cm
- Vidro temperado de 4mm  
Liso, listado ou fosco
- Ou em acrílico 2mm  
"aqua viva cristal"
- Fecho magnético
- Reversível
- Estanquidade alta

- Made of two doors
- Sliding opening
- Polished or lacquered in white aluminium profiles
- Standard height base 185cm and bath 140cm
- Tempered glass of 4mm  
choose plain, listed or bleak
- Or 2mm acrylic glass "aqua viva cristal"
- Magnetic lock
- Reversible
- High watertightness

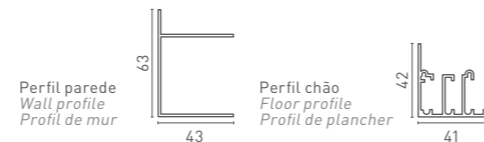

- Constitué pour deux portes
- Ouverture coulissante
- Profil d'aluminium polie ou laqué en blanc
- Hauteur standard base 185cm et baignoire 140cm
- Verre tempère de 4mm  
choisir plain, listé ou sombre
- Ou verre acrylique de 2mm "aqua viva cristal"
- Serrage magnétique
- Réversible
- Haute étanchéité

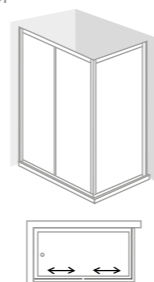

70

- Opções:
- Medidas especiais
  - Sérigrafias especiais
  - Painel lateral fixo
- Options:
- Special measures
  - Special silkscreen
  - Lateral fixed panel
- Options:
- Mesures spéciaux
  - Sérigraphie du verre
  - Panel lateral fixé

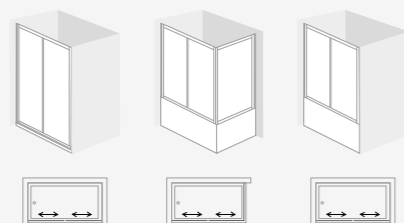

# ESMORIZ

Frontal | Shower Frontal  
Front de Douche

- Constituído por duas portas articuladas
- Abertura deslizando para o interior
- Perfil polido ou lacado a branco
- Altura standard 185cm
- Largura standard 80cm até 100cm
- Vidro temperado de 4mm  
liso, listado ou fosco
- Ou em acrílico 2mm "aqua viva cristal"
- Fecho magnético
- Reversível
- Estanquidade alta

- Made of two folding doors
- Sliding opening with folding to the interior
- Polished or lacquered in white aluminium profiles
- Standard height 185cm
- Standard width 80cm to 100cm
- Tempered glass of 4mm  
choose plain, listed or bleak
- Or 2mm acrylic glass "aqua viva cristal"
- Magnetic lock
- Reversible
- High watertightness

- Constitué pour deux portes articulées
- Ouverture coulissante avec articulation vers l'intérieur
- Profil d'aluminium polie ou laqué en blanc
- Hauteur standard 185cm
- Largeur standard 80cm à 100cm
- Verre tempère de 4mm  
choisir plain, listé ou sombre
- Ou verre acrylique de 2mm "aqua viva cristal"
- Serrage magnétique
- Réversible
- Haute étanchéité



71  
www.ajnoqueira.com

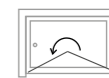
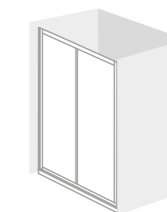
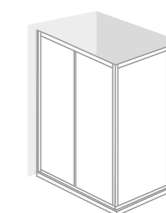

- Opções:
- Medidas especiais
  - Sérigrafias especiais
  - Painel lateral fixo

- Options:
- Special measures
  - Special silkscreen
  - Lateral fixed panel

- Options:
- Mesures spéciaux
  - Sérigraphie du verre
  - Panel lateral fixé

# FOLE

Frontal banheira e base | Shower Frontal  
Front de Douche

- Constituído por painéis em fole
- Abertura de correr
- Branco
- Altura de base 185cm ou banheira 150cm
- Em pvc
- Estantiquidade alta

- Made of two folding panels
- Sliding opening
- White
- Height base 185cm or bath 150cm
- Pvc
- High watertightness

- Constitué pour deux panneaux pliantes
- Ouverture coulissante
- Blanc
- Hauteur standard base 185cm ou baignoire 150cm
- Pvc
- Haute étanchéité

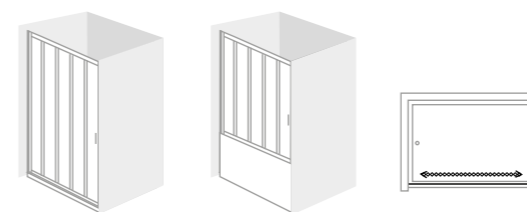

- Opções:
- Medidas especiais
  - Cores especiais
  - Painel lateral em fole

- Options:
- Special measures
  - Special colors
  - Lateral folding panel

- Options:
- Mesures spéciales
  - Couleurs spéciales
  - Panel lateral pliant

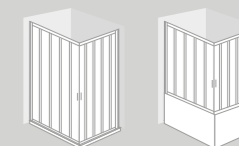

72



73  
www.ajnoqueira.com

# PORTA DOBRADIÇAS

Shower Door / Porte Douche



- Uma porta de abertura para o exterior
- Acessórios em latão cromado
- Perfil metalizado
- Altura standard 185cm
- Largura standard de 70cm, 80cm e 90cm
- Vidro temperado de 6mm liso, listado ou fosco
- Fecho magnético
- Medidas exatas necessárias para encomenda
- Estanquidade média

- Fixed panel and a opening door for the outside
- Chromed brass fittings and hinges
- Metalized aluminum profiles
- Standard height 185cm
- Standart width 70cm, 80cm and 90cm
- Tempered glass of 6mm choose plain, listed or bleak
- Magnetic lock
- Mandatory measures for ordering
- Medium watertightness

- Constitué pour une porte frontale d'ouverture vers l'extérieur et un panel fixé
- Accessoires en laiton chromée
- Profil d'aluminium métallisé
- Hauteur standard 185cm
- Largeur standard 70cm, 80cm et 90cm
- Verre tempère de 6mm choisir plain, listé ou sombre
- Serrage magnétique
- Mesures obligatoires à la demande
- Étanchéité à l'eau moyenne



74



- Opções:
- Medidas especiais
  - Serigrafias especiais
  - Abertura para dentro
- Options:
- Special measures
  - Special silkscreen
  - Inside opening
- Options:
- Mesures spéciales
  - Sérigraphie du verre
  - Ouverture vers l'intérieur

# PORTA BARRA

Shower Door / Porte Douche

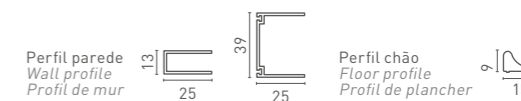

- Constituído por uma porta
- Abertura para o exterior ou interior
- Perfil metalizado ou lacado a branco
- Altura standard 185cm
- Largura standard de 70cm, 80cm e 90cm
- Vidro temperado de 6mm liso, listado ou fosco
- Fecho magnético
- Medidas exatas necessárias para encomenda
- Estanquidade média

- Made of one door
- Outside or inside opening
- Lacquered in white or metalized aluminium profiles
- Standard height 185cm
- Standard width 70cm, 80cm and 90cm
- Tempered glass of 6mm choose plain, listed or bleak
- Magnetic lock
- Mandatory measures for ordering
- Medium watertightness

- Constitué pour une porte
- Ouverture vers l'extérieur ou l'intérieur
- Profil d'aluminium métallisé ou laquée en blanc
- Hauteur standard 185cm
- Largeur standard 70cm, 80cm et 90cm
- Verre tempère de 6mm choisir plain, listé ou sombre
- Serrage magnétique
- Mesures obligatoires à la demande
- Étanchéité à l'eau moyenne

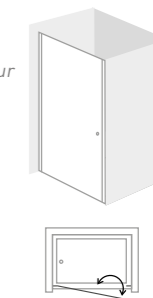

75



- Opções:
- Medidas especiais
  - Serigrafias especiais
- Options:
- Special measures
  - Special silkscreen
- Options:
- Mesures spéciales
  - Sérigraphie du verre

www.ajogueira.com

# PAINÉIS

PANELS | PANEAUX





# BERLENGA

Panel | Bath Panel | Panneau

- Constituído por um painel fixo e um móvel
- Abertura para o exterior e interior
- Acessórios em latão cromado
- Perfil metalizado
- Largura até 135cm com vidro móvel de 25cm
- Altura standard 195cm
- Vidro temperado de 6mm liso, listado ou fosco
- Estanquidade baixa

- Made of one fixed panel and one moving panel
- Outside and inside opening
- Chromed brass fittings
- Metalized profile
- Width up to 135cm with 25cm moving glass
- Standard height 195cm
- Tempered glass of 6mm choose plain, listed or bleak
- Low watertightness

- Constitué pour un panneau fixe et un mobile
- Ouverture vers l'extérieur et l'intérieur
- Accessoires en laiton chromée
- Profil métallisé
- Largeur jusqu'à 135cm avec verre mobile de 25cm
- Hauteur standard 195cm
- Verre tempère de 6mm choisir plain, listé ou sombre
- Étanchéité faible

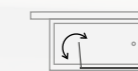
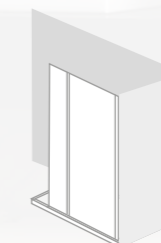

Perfil parede  
Wall profile  
Profil de mur



#### Opções:

- Medidas especiais
- Serigrafias especiais

#### Options:

- Special measures
- Special silkscreen

#### Options:

- Mesures spéciaux
- Sérigraphie du verre



# CASCAIS

Painel | Bath Panel | Panneau

- Constituídos por um painel fixo
- Acessórios em inox
- Perfil metalizado
- Altura standard 200cm
- Vidro temperado de 6mm ou 8mm liso, listado ou fosco
- Necessário a medida do fixador
- Estanquidade baixa

- Made of one panel
- Stainless steel fittings
- Metalized aluminium profiles
- Standard height 200cm
- Tempered glass of 6mm or 8mm choose plain, listed or bleak
- Mandatory measures for fixing bar
- Low watertightness

- Constitué pour un panel fixe
- Accessoires en acier inox
- Profil d'aluminium blanc
- Hauteur standard 200cm
- Verre tempère de 6mm ou 8mm choisir plain, listé ou sombre
- Mesures obligatoires de fixation barre
- Étanchéité faible

Perfil parede  
Wall profile  
Profil de mur

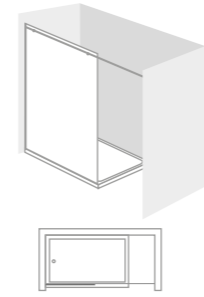

# LAVOS

Painel | Bath Panel | Panneau

- Constituídos por um painel fixo
- Acessórios em latão cromado
- Perfil metalizado ou branco
- Altura standard 195cm
- Vidro temperado de 6mm ou 8mm liso, listado ou fosco
- Necessário a medida do fixador
- Estanquidade baixa

- Made of one panel
- Chromed brass fittings
- Metalized or white aluminium profiles
- Standard height 195cm
- Tempered glass of 6mm or 8mm choose plain, listed or bleak
- Mandatory measures for fixing bar
- Low watertightness

- Constitué pour un panel fixe
- Accessoires en laiton chromée
- Profil d'aluminium métallisé ou blanc
- Hauteur standard 195cm
- Verre tempère de 6mm ou 8mm choisir plain, listé ou sombre
- Mesures obligatoires de fixation barre
- Étanchéité faible

Perfil parede  
Wall profile  
Profil de mur

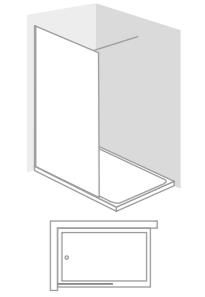

80

- Opções:
- Medidas especiais
  - Serigrafias especiais

- Options:
- Special measures
  - Special silkscreen

- Options:
- Mesures spéciaux
  - Sérigraphie du verre



81

- Opções:
- Medidas especiais
  - Serigrafias especiais
  - Quantidade de painéis variável

- Options:
- Special measures
  - Special silkscreen
  - Variable quantity of panel

- Options:
- Mesures spéciaux
  - Sérigraphie du verre
  - Quantité de panneaux variable

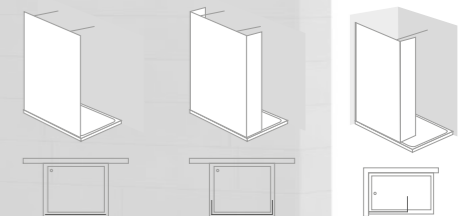

www.ajnogueira.com

# FUZETA

Painel | Bath Panel | Panneau

- Acessórios em latão cromado
- Perfil metalizado ou branco
- Altura standard 195cm
- Vidro temperado de 6mm e 8mm liso, listado ou fosco
- Medidas exatas necessárias para encomenda
- Estanquidade baixa

- Chromed brass fittings
- Metalized or white aluminium profiles
- Standard height 195cm
- Tempered glass of 6mm and 8mm choose plain, listed or bleak
- Mandatory measures for ordering
- Low watertightness

- Accessoires en laiton chromée
- Profil d'aluminium métallisé ou blanc
- Hauteur standard 195cm
- Verre tempère de 6mm et 8mm choisir plain, listé ou sombré
- Mesures obligatoires à la demande
- Étanchéité faible

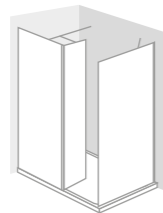

Perfil parede  
Wall profile  
Profil de mur



25

82



**Opções:**

- Medidas especiais
- Serigrafias especiais
- Quantidade de painéis variável
- Vidro de 6mm

**Options:**

- Special measures
- Special silkscreen
- Variable quantity of panel
- 6Mm glass

**Options:**

- Mesures spéciales
- Sérigraphie du verre
- Quantité de panneaux variable
- Verre avec 6mm

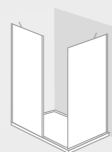



84

# CAMINHA

Painel | Bath Panel | Panneau

- Constituído por um painel fixo e um móvel
- Abertura para o exterior e interior
- Acessórios em latão cromado
- Perfil polido ou lacado a branco
- Largura até 140cm
- Altura standard 185cm
- Vidro temperado de 6mm
- liso, listado ou fosco
- Estanquidade baixa

- *Made of one fixed panel and one moving panel*
- *Outside and inside opening*
- *Chromed brass fittings*
- *Lacquered in white or metalized aluminium profiles*
- *Width up to 140cm*
- *Standard height 185cm*
- *Tempered glass of 6mm*
- *choose plain, listed or bleak*
- *Low watertightness*

- *Constitué pour un panneau fixe et un mobile*
- *Ouverture vers l'extérieur et l'intérieur*
- *Accessoires en laiton chromée*
- *Profil d'aluminium métallisé ou laquée en blanc*
- *Largeur jusqu'à 140cm*
- *Hauteur standard 185cm*
- *Verre tempère de 6mm*
- *choisir plain, listé ou sombre*
- *Étanchéité faible*



Canto angular  
Sharp corner  
Angle vif  
**OFIR**

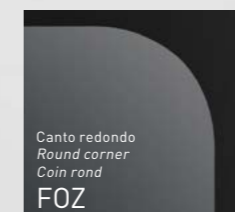

Canto redondo  
Round corner  
Coin rond  
**FOZ**

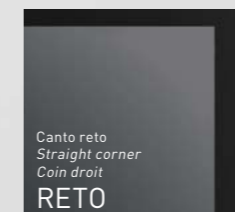

Canto reto  
Straight corner  
Coin droit  
**RETO**

- Opções:
- Medidas especiais
  - Serigrafias especiais
  - Canto redondo/angular/direito

- Options:
- *Special measures*
  - *Special silkscreen*
  - *Corner round / angle / right*

- Options:
- *Mesures spéciaux*
  - *Sérigraphie du verre*
  - *Coin ronde / angle / droite*

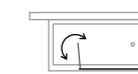
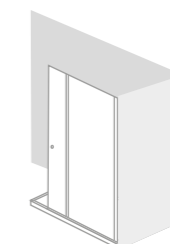

Perfil parede  
Wall profile  
Profil de mur

85

www.ajnoqueira.com

# NAZARÉ

Painel Duplo | Bath Double Panel  
Panneau Double à Bain

- Um painel fixo e um de abertura para o exterior
- Acessórios em latão cromado
- Perfil metalizado
- Altura standard 140cm
- Largura standard 40cm+70cm
- Vidro temperado de 6mm liso, listado ou fosco
- Estanquidade baixa

- Fixed panel and a opening panel for the outside
- Chromed brass fittings and hinges
- Metalized aluminum profiles
- Standard height 140cm
- Standard width 40cm+70cm
- Tempered glass of 6mm choose plain, listed or bleak
- Low watertightness

- Constitué pour une panneau fixé e un panneau d'ouverture vers l'extérieur
- Accessoires en laiton chromée
- Profil d'aluminium métallisé
- Hauteur standard 140cm
- Largeur standard 40cm+70cm
- Verre tempère de 6mm choisir plain, listé ou sombré
- Étanchéité faible

Perfil parede  
Wall profile  
Profil de mur

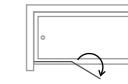
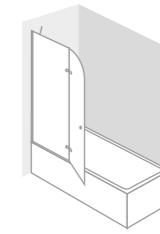

86

87

Canto angular  
Sharp corner  
Angle vif  
OFIR

Canto redondo  
Round corner  
Coin rond  
FOZ

Canto reto  
Straight corner  
Coin droit  
RETO

- Opções:
- Medidas especiais
  - Serigrafias especiais
  - Abertura para dentro
  - Canto redondo/angular/direito

- Options:
- Special measures
  - Special silkscreen
  - Inside opening
  - Corner round / angle / right

- Options:
- Mesures spéciaux
  - Sérigraphie du verre
  - Ouverture vers l'intérieur
  - Coin ronde / angle / droite

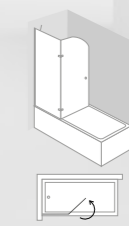

www.ajnoqueira.com

# DOBRADIÇASIMPLES

Panel Simple | Bath Simple Panel Hinge / Panneau Simple

- Constituído por um painel móvel
  - Abertura para o exterior
  - Acessórios em latão cromado
  - Altura standard 140cm
  - Largura standard 80cm
  - Vidro temperado de 6mm liso, listado ou fosco
  - Estanquidade baixa
- Made of one moving panel
  - Outside opening
  - Chromed brass fittings
  - Standard height 140cm
  - Standard width 80cm
  - Tempered glass of 6mm choose plain, listed or bleak
  - Low watertightness
- Constitué pour un panneau mobile
  - Ouverture vers l'extérieur
  - Accessoires en laiton chromée
  - Hauteur standard 140cm
  - Largeur standard 80cm
  - Verre tempère de 6mm choisir plain, listé ou sombré
  - Étanchéité faible

Dobradiça  
Hinge  
Charnière

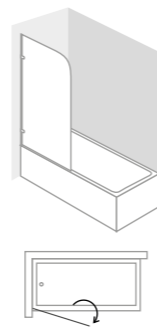

# DOBRADIÇADUPLO

Panel Duplo | Bath Double Panel Hinge / Double Panneau

- Constituído por dois painéis móveis
  - Abertura para o exterior
  - Acessórios em latão cromado
  - Altura standard 140cm
  - Largura standard 70cm+40cm
  - Vidro temperado de 6mm liso, listado ou fosco
  - Estanquidade baixa
- Made of two moving panels
  - Outside opening
  - Chromed brass fittings
  - Standard height 140cm
  - Standard width 70cm+40cm
  - Tempered glass of 6mm choose plain, listed or bleak
  - Low watertightness
- Constitué pour deux panneaux mobiles
  - Ouverture vers l'extérieur
  - Accessoires en laiton chromée
  - Hauteur standard 140cm
  - Largeur standard 70cm+40cm
  - Verre tempère de 6mm choisir plain, listé ou sombré
  - Étanchéité faible

Dobradiça  
Hinge  
Charnière

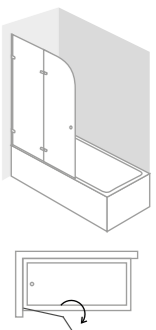

# BARRASIMPLES

Painel Simples | Bath Simple Panel / Panneau à Bain Simple

- Constituído por um painel móvel
- Abertura para o exterior e interior
- Perfil polido ou lacado a branco
- Altura standard 140cm
- Largura standard 85cm
- Vidro temperado de 6mm liso, listado ou fosco
- Estanquidade baixa
- Made of one moving panel
- Outside and inside opening
- Lacquered in white or polished aluminium profiles
- Standard height 140cm
- Standard width 85cm
- Tempered glass of 6mm choose plain, listed or bleak
- Low watertightness
- Constitué pour un panneau mobile
- Ouverture vers l'extérieur et l'intérieur
- Profil d'aluminium polie ou laquée en blanc
- Hauteur standard 140cm
- Largeur standard 85cm
- Verre tempère de 6mm choisir plain, listé ou sombré
- Étanchéité faible

Perfil parede  
Wall profile  
Profil de mur

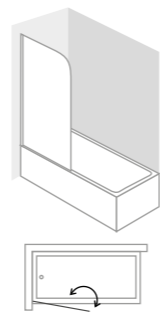
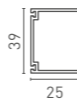

# BARRADUPLO

Painel Duplo | Bath Double Panel / Panneau Double à Bain

- Constituído por dois painéis móveis
- Abertura para o exterior e interior
- Perfil polido ou lacado a branco
- Altura standard 140cm
- Largura standard 75cm+45cm
- Vidro temperado de 6mm liso, listado ou fosco
- Estanquidade baixa
- Made of two moving panels
- Outside and inside opening a
- Lacquered in white or polished aluminium profiles
- Standard height 140cm
- Standard width 75cm+45cm
- Tempered glass of 6mm choose plain, listed or bleak
- Low watertightness
- Constitué pour deux panneaux mobiles
- Ouverture vers l'extérieur et l'intérieur
- Profil d'aluminium polie ou laquée en blanc
- Hauteur standard 140cm
- Largeur standard 75cm+45cm
- Verre tempère de 6mm choisir plain, listé ou sombré
- Étanchéité faible

Perfil parede  
Wall profile  
Profil de mur

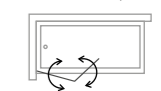
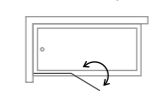
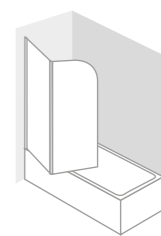
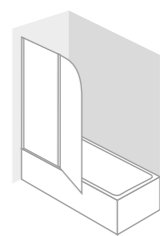
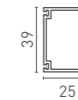

90

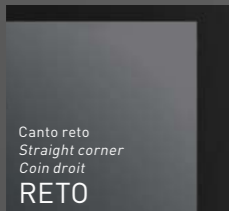

91



- Opções barra duplo e simples:
- Medidas especiais
  - Serigrafias especiais
  - Canto redondo/angular /direito

- Options double and simple barra:
- Special measures
  - Special silkscreen
  - Corner round / angle / right

- Options double et simple barra:
- Mesures spéciaux
  - Sérigraphie du verre
  - Coin ronde / angle / droite

www.ajnoqueira.com



# ESPINHOCROMO

## SEM TOALHEIRO

Painel Simples sem Toalheiro  
*Simple Chromed Bath Panel*  
*Panneau Simple*

- Constituído por um painel móvel
- Abertura para o exterior e interior
- Perfil cromado
- Altura standard 140cm
- Largura standard 85cm
- Vidro temperado de 6mm – liso
- Canto redondo
- Estanquidade baixa

- Made of one moving panel
- Outside and inside opening
- Chromed aluminium profiles
- Standard height 140cm
- Standard width 85cm
- Tempered glass of 6mm choose plain
- Round corner glass
- Low watertightness

- Constitué pour un panneau mobile
- Ouverture vers l'extérieur et l'intérieur
- Profil d'aluminium chromé
- Hauteur standard 140cm
- Largeur standard 85cm
- Verre tempère de 6mm choisir plain
- Coin round
- Étanchéité faible

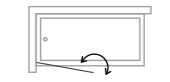
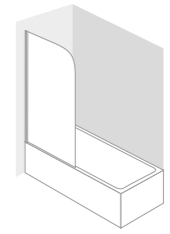

Perfil parede  
 Wall profile  
 Profil de mur



- Opções:
- Toalheiro cromado
  - Chromed towel support
  - Porte-serviettes chromé

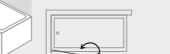
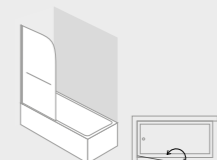

## VIDROS

GLASSES / VERRES



Transparente



Fosco

## FOSCAGEM TIPO 1

SANDBLASTING GLASS TYPE 1 / SABLAGE VERRE TYPE 1

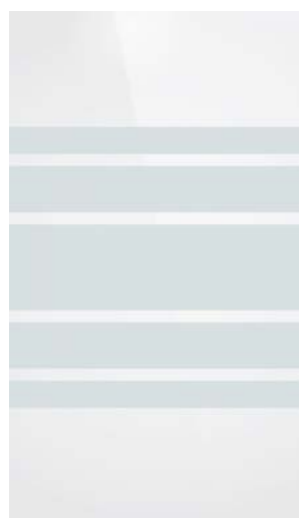

N° 2



N° 4

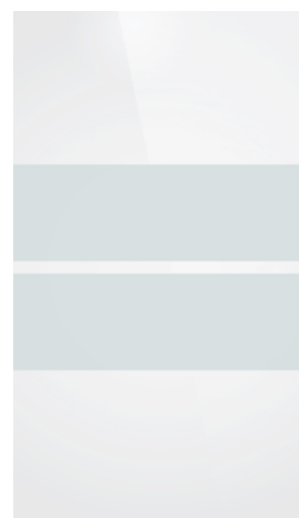

N° 8

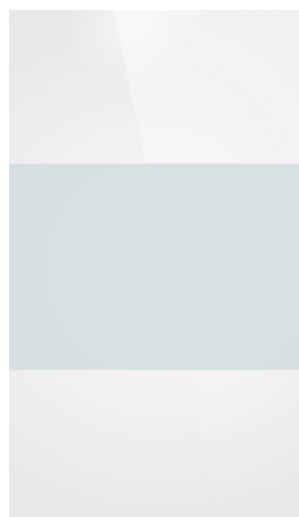

N° 9

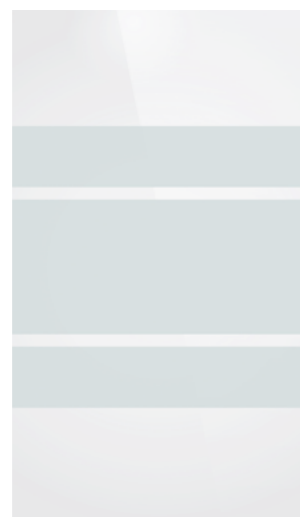

N° 10



N° 12

NOTA: Identificar sempre posição de aplicação (esquerda/Direita).

NOTE: Always identify application position (left / right).

REMARQUE: Identifiez toujours la position de l'application (gauche / droite).

## FOSCAGEM TIPO 2

SANDBLASTING GLASS TYPE 2 / SABLAGE VERRE TYPE 2

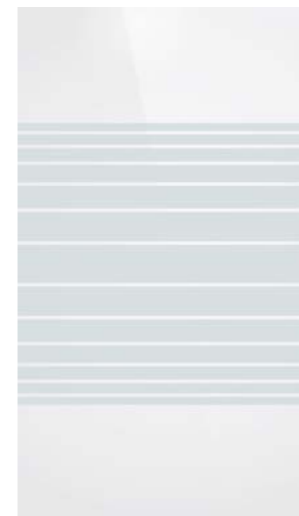

N° 7



N° 11



N° 13



N° 14

## SOB CONSULTA

ON REQUEST / SUR DEMANDE



N° 3



N° 15



N° 16



N° 17 - Espelhado



N° 18



N° 19

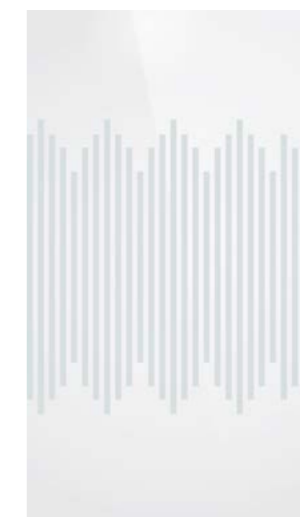

N° 20



N° 21



## CONDIÇÕES DE VENDA / CONDITIONS OF SALE / CONDITIONS DE VENTE

1. Os preços constantes da tabela são sujeitos a Iva à taxa em vigor e podem ser alterados sem aviso prévio.
2. As encomendas devem ser realizadas por escrito e podem ser parcialmente executadas.
3. O cancelamento de encomendas estará sempre sujeito à concordância da AJNogueira, sob pena de débito dos custos já incorridos.
4. Os prazos de entrega são sempre indicativos e não poderão ser usados para justificação de atrasos nos pagamentos.
5. Os pagamentos serão obrigatoriamente a pronto pagamento até concessão de crédito.
6. O desconto de pronto pagamento é de 2% sobre o valor líquido da mercadoria.
7. Os prazos de pagamento são descritos na factura. A AJNogueira reserva-se ao direito de cobrar juros se houver atrasos, totais ou parciais, relativamente aos pagamentos, bem como condicionar as entregas de encomendas.
8. As reclamações de defeito de material, serão aceites desde que efectuadas em 8 dias após emissão da factura.
9. Em caso de conflito entre as partes, deve ser o Tribunal da Comarca do Baixo Vouga definido como Barra competente.

1. Prices presented on the price table are object of taxation and are object of variations without mandatory information to the clients.
2. The orders must be written and may be partially executed.
3. For order cancellation it must always have the agreement of AJNogueira, and the client may be responsible for this cost.
4. Indicated delivery times are for orientation and must not be used as a condition for payments delay.
5. The payments are against delivery in full until credit concession.
6. The cash discount is 2% of the net value of the merchandise.
7. AJNogueira may claim interest in case of late payment. The payment conditions are presented on the invoice.
8. Material defect must be presented in between 8 days of the invoice or the delivery documents.
9. In case of conflict between the client and AJNogueira, it must be the Court of Baixo Vouga in Portugal the one to decide the conflict.

1. Les prix présente sur notre tableaux de prix sont sujet de taxes, et il est acceptable ces modifications sans obligatoire avis aux clients.
2. Les commandes sont obligatoirement présents par écrit et puissant être seulement partiellement exécutés.
3. Pour annuler des commandes il faut la acceptation de AJNogueira et le client puisse être responsabilise pour des couts.
4. Les délais présentes sont pour référence et n'est pas acceptable les utiliser pour créer des délais de paiement.
5. Les paiements sont obligatoirement contre livraison jusqu'au moment de concession de crédit.
6. L'escompte est de 2% de la valeur nette de la marchandise.
7. AJNogueira peut demander le paiement de intérêt si le paiement est fait hors des conditions inscrites sur la facture.
8. Les réclamations pour des defaults de matériel sont acceptes seulement jusqu'à 8 jours après facture ou le bon de livraison.
9. En cas de conflit, c'est le tribunal du Baixo Vouga au Portugal celui qui doit être utilise.

126

### Informação importante / Important information / Informations importantes

1. Para frontais entre paredes, tirar medidas em cima e em baixo.

1. For the frontal shower, there must be taken dimensions on top and bottom.

1. Pour des duche front, prier de prendre des mesures a sommet et en haute.

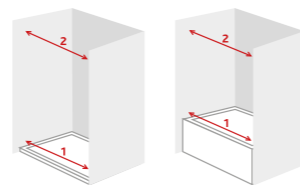

2. Para frontais com lateral e cabines, tirar medidas da parede à extremidade da base.

2. For the frontal shower and shower cabins, it's necessary to know the distance between the wall and the end of tray.

2. Pour des duche front avec laterale e cabines de duche, prier de prendre des mesures au sommet, de la paroi jusqu'à receveur de duche.

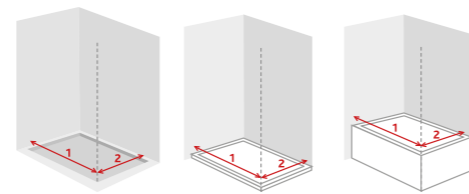

3. Identificar sempre na encomenda se é para aplicar em banheira, base ou chão.

3. Always identify in order if it is to apply in bath, base or floor.

3. Toujours identifier dans l'ordre si elle doit s'appliquer dans le bain, la base ou le plancher.

4. Os modelos com calhas de parede que permitam afinação, são mais adequados para situações em que as paredes sejam mais irregulares ou desaprumadas.

5. O AJNogueira, reserva-se ao direito de cobrar portes de transporte aquando de encomendas com carácter de urgência e cujas entregas nos nossos carros excedam o prazo pretendido pelo cliente.

4. The models with mandatory regulation are best suited for irregular walls.

5. AJNogueira, reserves the right to charge for the shipping if is urgent and for whose deliveries, in our cars, that exceed the desired period by the customer.

4. Les modèles avec système de prison au paroi (coulisse) avec réglage, sont meilleurs d'utiliser sur des parois beaucoup irréguliers.

5. AJNogueira, se réserve le droit de facturer le transport si c'est urgent et dont les livraisons, dans nos voitures, qui dépasse la période souhaitée par le client.

### ESTANQUIDADE / WATERTIGHTNESS / ÉTANCHÉITÉ

ESTANQUIDADE ALTA / High watertightness / Haute étanchéité 90% - 100%

ESTANQUIDADE MÉDIA / Medium watertightness / Étanchéité à l'eau moyenne 75% - 90%

ESTANQUIDADE BAIXA / Low watertightness / Étanchéité faible Inf. 75%

CABINES  
DE DUCHE &  
RESGUARDOS  
DE BANHO



Apartado 3069 - Barrosinhas  
3754-901 Águeda

Tlf.: 234 648 597-8

Fax: 234 648 595

[a.j.nogueira@sapo.pt](mailto:a.j.nogueira@sapo.pt)

[www.ajnogueira.com](http://www.ajnogueira.com)

GPS: N 40° 35' 57,92"  
W 8° 27' 40,97"